

CABINETS AND DRAWERS
SECTION "S"

DEALER PRODUCTS, INC
1185 108TH ST.
GRAND PRAIRIE, TX 75050
800-999-8828

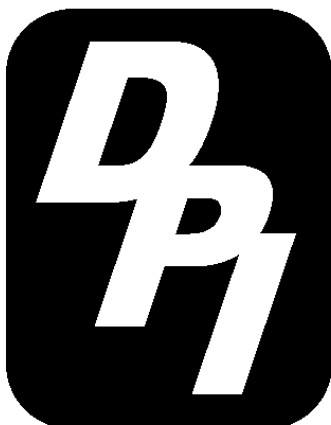



Section "S"

INDEX

DEALER PRODUCTS, INC
1185 108TH ST.
GRAND PRAIRIE, TX 75050
800-999-8828

“S” SECTION

INDEX

<u>Description</u>	<u>Page #</u>
Metal Compartmented Drawers	S-001
Miscellaneous Racks and Cabinets	S-007 - S-008
Plastic Compartmented Drawers	S-002
Service Equipment Accessories	S-006
Slide Racks	S-004
Storage Bin	S-003
Storage Cabinets	S-005



DEALER PRODUCTS, INC.

METAL COMPARTMENTED DRAWERS

Metal Drawers

All Drawers are Manufactured of Prime Cold Rolled Steel and Finished in Rust and Acid Resistant Baked Enamel. Drawers have Inserts of High Impact Plastic. These Inserts have Rounded Scoops, Making it Easy to Remove Small Parts, and their Permanent Finish keeps the Original Color Even with Heavy Use. All Models Have Covers Designed to Stay Open for Easy Access, Making it Simple to Read the Cover Labels.



DMADL2GR



DMDL16GR and
DMDS16GR



DMDL21GR

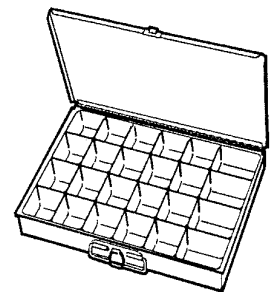

DMDL24GR

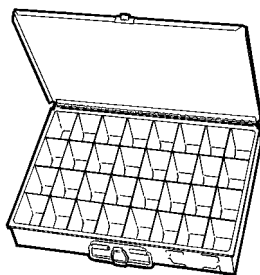

DMDL32GR

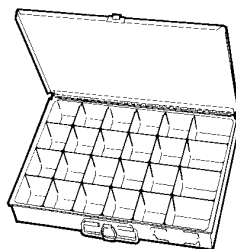

DMDS24GR



DMADS1GR



DMDL6H



DMDL6V

DPI Number	Drawer Width	Drawer Depth	Drawer Height	Drawer Color	# Of Slots
DMADL2GR	18"	12"	3"	Gray	Variable
DMDL16GR	18"	12"	3"	Gray	16
DMDL21GR	18"	12"	3"	Gray	21
DMDL24GR	18"	12"	3"	Gray	24
DMDL32GR	18"	12"	3"	Gray	32 w/ TCH Logo
DMDS16GR	13-3/8"	9-1/4"	2"	Gray	16
DMDS24GR	13-3/8"	9-1/4"	2"	Gray	24
DMADS1GR	13-3/8"	9-1/8"	2"	Gray	Variable
DMDL6H	18"	12"	3"	Gray	6 Horiz.
DMDL6V	18"	12"	3"	Gray	6 Vert



DEALER PRODUCTS, INC.

PLASTIC COMPARTMENTED DRAWERS

Polypropylene Boxes

Extremely Durable Polypropylene Boxes are Molded with Heavy Duty, Heat-Sealed Hinges. These Boxes Resist Solvents such as Gasoline, Oil, and Most Common Chemicals. An Excellent Box for Organizing and Carrying Small Items for the Mechanic, Plumber, Electrician, and Handyman.

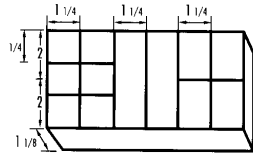

FLA201

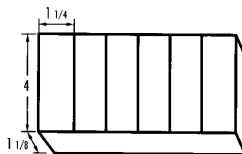

FLA203

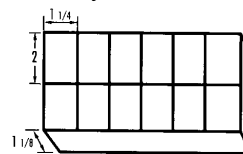

FLA208

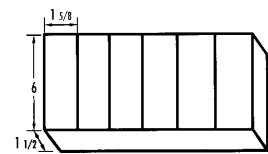

FLA606

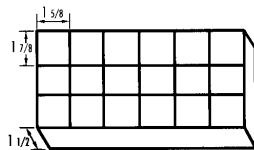

FLA618

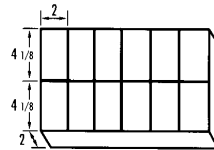

FLA812

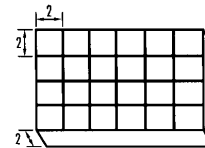

FLA824

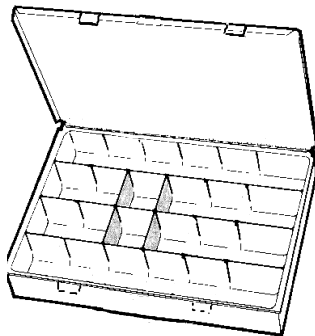

DMLPADJ

Polypropylene Box w/
Adjustable Dividers.
Box is 13" X 8-3/4" X 2-1/8" in
Size, Includes Dividers to Make
Up t 24 Slots 2-1/16" X 2-1/16"
in size

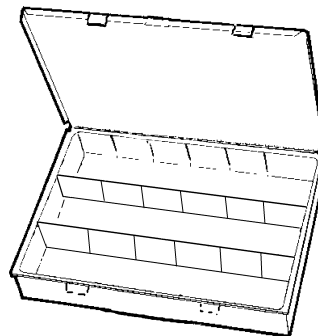

DMSPADJ

Polypropylene Box w/
Adjustable Dividers.
Box is 10-7/8" X 6-1/2" X 1-1/2"
in Size, Includes Dividers to
Make Up t 18 Slots
1-5/8" X 2" in Size

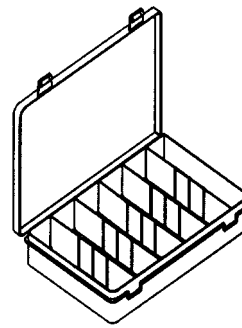

DI80106

6-3/4" X 11" X 1-3/4"
Polypropylene Plastic
Transparent tray.
6 compartments;
1 per package

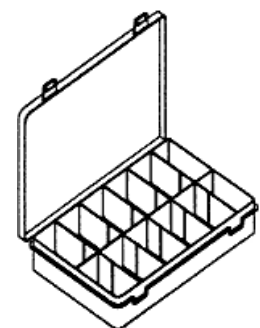

DMSP12

6-3/4" X 11" X 1-3/4"
Polypropylene Plastic
Transparent tray.
12 compartments;
1 per package



DEALER PRODUCTS, INC.

STORAGE BINS

Designed as Heavy Duty Units for Storing a Wide Variety of Small Parts, Bins are Extremely Sturdy as the Result of Being Welded on Specially Designed Machines. They are Produced from Prime Cold Rolled Steel and will Not Warp, Twist, or Sag. Fully Hemmed Label Holders provide Adequate Space for Content Identification. Each Divider is Hemmed in a Tear Drop Design to Avoid Sharp Edges, and Vertical Ribs Provide Added Strength. Bases to Raise Units are Available for Use with Most Models.

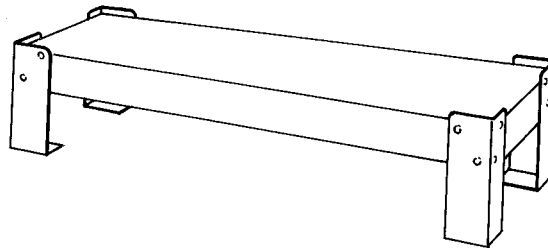

DMBBCGR

12" Deep Bin Base.

Sturdy, All Steel Base Available for
DPI Bin #'s DM40BGR, DM72BGR.

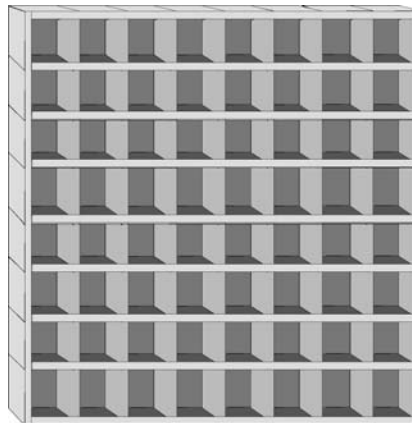

Storage and Multi-Purpose Bins

DPI Number	Width	Height	Depth	Bins	Bin Depth	Bin Height	Bin Width	Bin Color
DMMB36GR	23-3/4"	23-3/4"	4-3/4"	36"	4-5/8"	3-3/4"	3-7/8"	Gray
DM40BGR	33-3/4"	23-7/8"	12"	40"	11-7/8"	4-1/4"	4"	Gray
DM72BGR	33-3/4"	42"	12"	72"	11-7/8"	4-1/2"	4"	Gray



SLIDE RACKS

Small and Large Slide Racks

Racks are Manufactured of Prime Cold Rolled Steel Finished in Rust and Acid Resistant Baked Enamel. All Parts of the Slide Rack, Including the Cradle which Supports the Drawers and Easy-Glide Coated Slides and Tracks, are Tooled for Quality and Uniformity. Racks are Reinforced for Strength and Designed to Support Loaded Drawers in the Open Position without Tilting. Heavy-Duty Models Offer Exclusive "Easy-Glide" Slides, Specially Designed/Telescoping Tracks. A Center Panel Keeps Drawers from Falling through the Cradles and Special Tab Holders Prevent Units from Being Accidentally Pulled from the Rack.

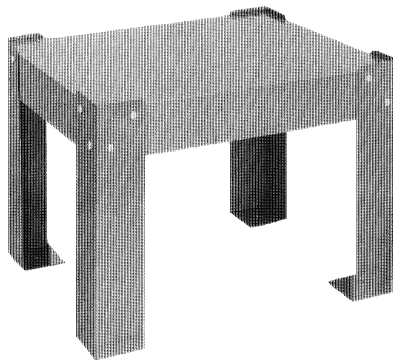

DMBLRGR

Rack Base.

Width: 15-1/2";

Height: 15-1/8";

Diameter: 12-1/8"

Available for All Small Slide Racks.

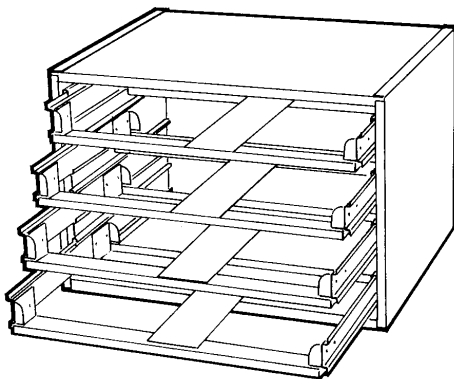

DM4SRGR and **DM4LRGR**

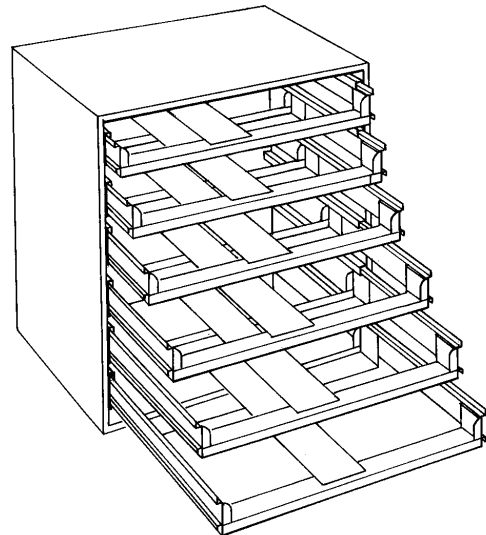

DM6SRGR

DPI Number	Length	Depth	Height	Drawers	Color
DM4SRGR	15-1/4"	11-3/4"	11-1/4"	4	Gray
DM4LRGR	20"	15-3/4"	15"	4	Gray
DM6SRGR	15-1/4"	11-3/4"	16-5/16"	6	Gray



STORAGE CABINETS

Steel Cabinets are Manufactured on Completely Automated Tooling to Provide Uniformity. Only Prime Cold-Rolled Steel is Used. Finishes are Rust and Acid Resistant Baked Enamel. Vertical Supports Provide Great Strength, and Embossed Mounting Holes allow the Cabinets to be Stacked. Drawers have Two Runners for Smooth, Easy Travel and are Prevented from being Accidentally Pulled out of the Cabinet by a Positive Stop. Cabinets Also Feature Interlocked Design.

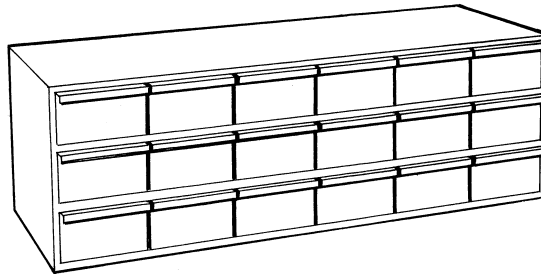

STORAGE CABINETS

Specifications	DM9DGR	DM18DGR
	CABINET DIMENSIONS	
Width	17-1/4"	33-3/4"
Height	10-7/8"	10-7/8"
Depth	11-5/8"	11-5/8"
Drawers	9	18
	DRAWER DIMENSIONS	
Width	5-3/8"	5-5/16"
Height	2-3/4"	2-3/4"
Depth	11-1/4"	11-3/16"
Dividers	18	36



SATCHEL-STYLE CASES

Satchel-Style Cases Molded from Rugged Copolymer Resins. Cases are Rustproof, Odor and Oil Resistant.

DPI Number	Case Size: WxHxD	Number Of Compartments
FL10162	18-1/2" x 13" x 3"	4 to 16
FL10212	18-1/2" x 13" x 3"	21
FL10242	18-1/2" x 13" x 3"	24
FL10322	18-1/2" x 13" x 3"	32



DEALER PRODUCTS, INC.

SERVICE EQUIPMENT ACCESSORIES

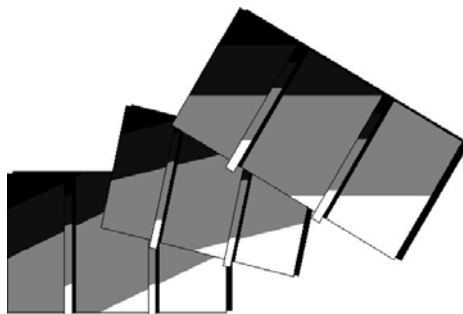

DIVIDERS FOR TRAYS AND CABINETS

<u>DPI Number</u>	<u>Dividers For</u>
DM18DDIVIDER	DM18DGR
DMADLDIVIDER	DMADL2GR
DMADSDIVIDER	DMADS1GR

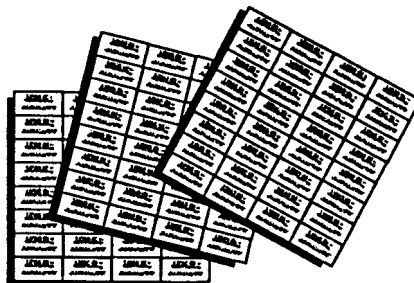

USS Labels

Pressure Sensitive Bin Labels for USS or SAE Cap Screws in 6 Page Sets. Printed Black on Heavy Coated Yellow Paper.

Metric Labels

Pressure Sensitive Metric Label Set Consists of Nine Pages Printed Black on Heavy Coated White Paper.

DMUSSLABEL
USS Label Set

DMSAELABEL
SAE Label Set

DMMETRICLBL
Metric Label Set



MISCELLANEOUS RACKS AND CABINETS

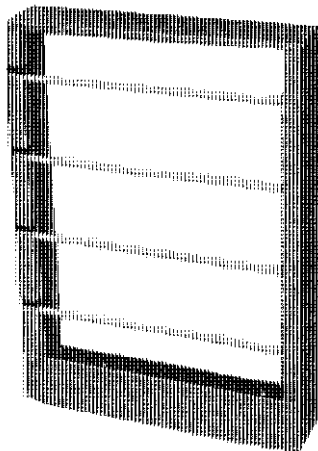

DMWIRERACKGR

Rack for Spooled Primary Wire.
Width: 26-1/8"; Height: 37-1/8"; Depth: 6".
Holds 4 Wire Sizes. Gray in Color.



WHFC16

Stock Cabinet - Empty.
Contains 16 Clear Plastic Drawers that can be Divided into Two or Three Sections. Illustrated Color Labels are Available to Provide Instant Identification of Drawer Contents. Size: 16-1/8" X 11-3/4" X 9"; Weights 13 Lbs.

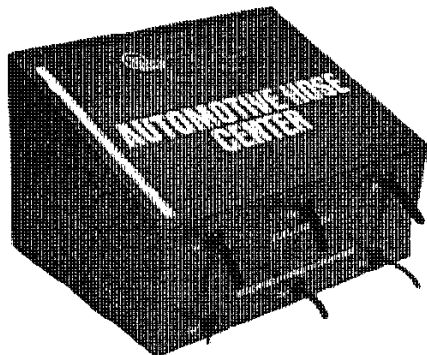

CR1600D

Hose Cabinet for Fuel and Vacuum Hoses.
Width: 19"; Height: 12"; Depth: 14".
Has 6 Hose Sections.



DI80352

Steel Rack for Plastic Trays;
Holds 5 11 X 6-3/4" Polypropylene Trays;
Not Lockable.



DEALER PRODUCTS, INC.

MISCELLANEOUS RACKS AND CABINETS

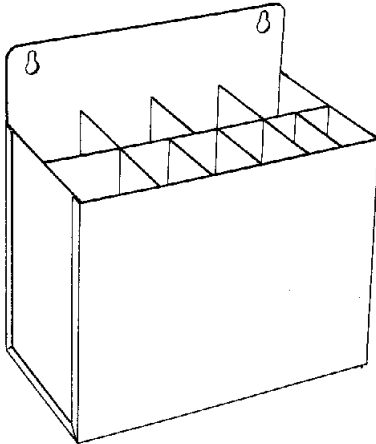

DMKEYSTOCK

Cabinet for Keystock.

Width: 12-1/2"; Height: 12"; Depth: 6-1/8".
10 Sections, Gray in Color

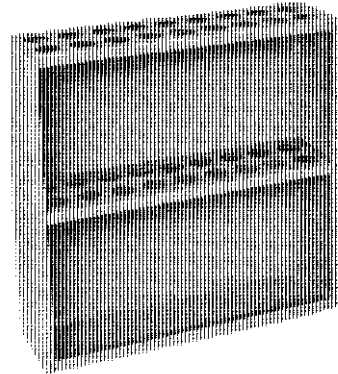

DMTRCGR

Threaded Rod Rack.

Width: 14"; Height: 24-3/8"; Depth: 6-7/8".
Rack has 18 Sections that are 2-1/8" in Diameter each.

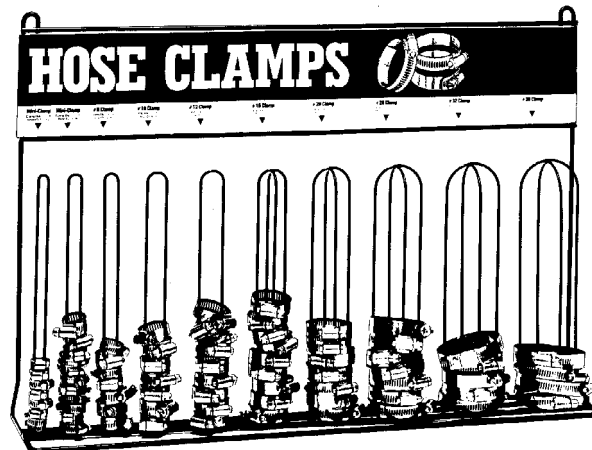

TDHCR

Hose Clamp Rack.

Ten Post Rack Allows Easy Access to Adjustable
Hose Clamps. Rack Holds 10 Sizes. DPI Numbers:

TD6202, TD6203, TD5006, TD5010, TD5012,
TD5016, TD5020, TD5028, TD5032, and TD5036.

CLAMPS ARE NOT INCLUDED