



AIR CONDITIONING PRODUCTS

SECTION "L"

DEALER PRODUCTS, INC
1185 108TH ST.
GRAND PRAIRIE, TX 75050
800-999-8828





Section “L” INDEX

DEALER PRODUCTS, INC
1185 108TH ST.
GRAND PRAIRIE, TX 75050
800-999-8828





DEALER PRODUCTS, INC.

O-RING SIZE CHART

(Actual Sizes Shown)

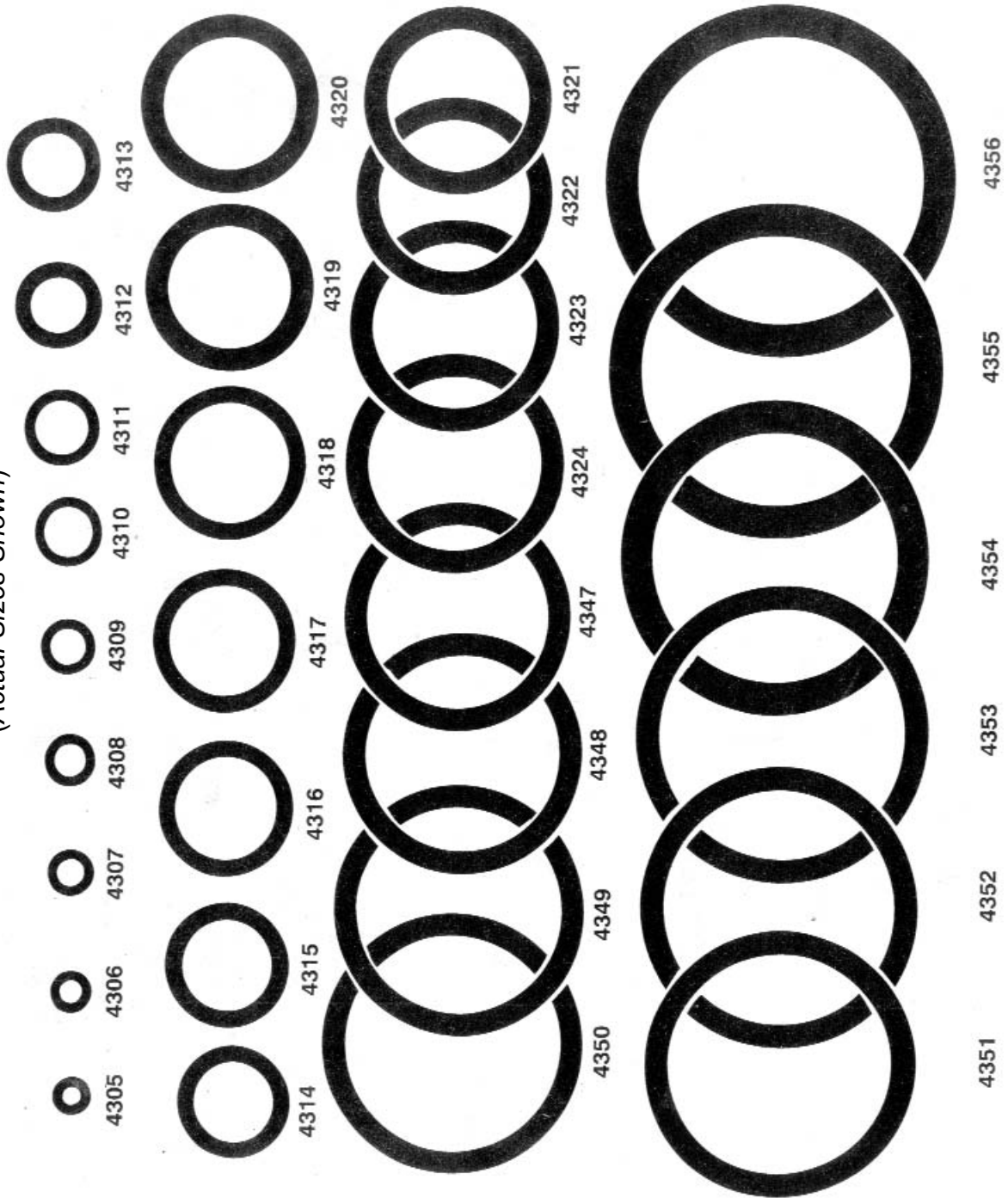





DEALER PRODUCTS, INC.

O-RINGS FOR AUTOMOTIVE AIR CONDITIONING



DA10006
#6 Hose Fitting



DA10008
#8 Hose Fitting

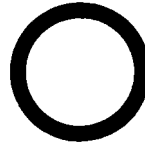

DA10010
#10 Hose Fitting

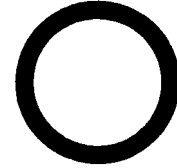

DA10012
#12 Hose Fitting



DA10604
#6 Captured



DA10607
#8 Captured



DA257112
G.M. #10 Captured

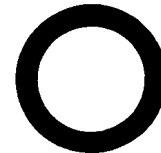

DA10113
#12 Captured



DA10016
Oil Filler Plug Seal

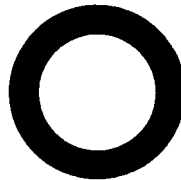

DA257208
Chrysler T.V.X.

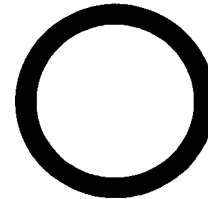

DA257117
Ford T.X.V. Seal
3/16" X 1"



DA257008
Capillary Tube Seal

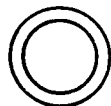

DA257012
Cycling Switch



DA257014
V.I.R. Sight Glass

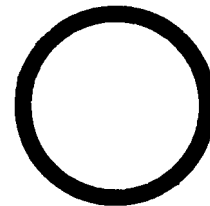

DA257020
Combination Valve,
S.T.V.



DEALER PRODUCTS, INC.

O-RINGS FOR AUTOMOTIVE AIR CONDITIONING



DA257901

Nissan #6 Expansion
Valve

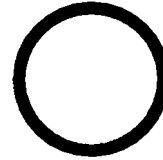

DA257207

#12 Spring Lock
Coupling

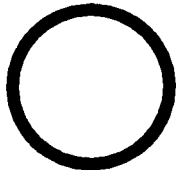

DA10018

#12 GM Hose Fitting
Seal

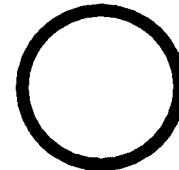

DA257018

#12 Compression

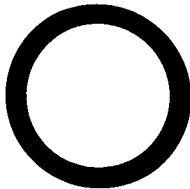

DA257910

FS-6, C-171
Compressor Fitting

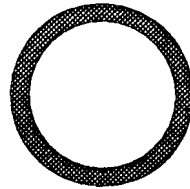

DA257904

Ford Nipple - Red

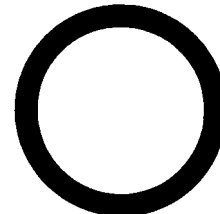

DA257118

Superheat Switch

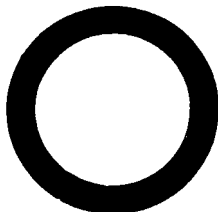

DA10017

GM Service Valve

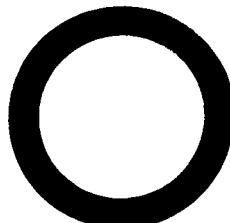

DA257212

Chrysler T.V.X.

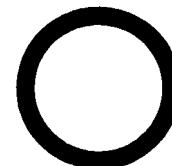

DA10012

#12 Hose Fitting



DEALER PRODUCTS, INC.

FORD GREEN "O"-RINGS

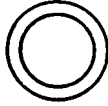

DA257012G

Ford Cycling Switch
O-Ring - Green;



DA257221

#6 Green
Ford



DA257222

#8 Green
Ford



DA257223

#10 Green
Ford



DA257224

#12 Green
Ford

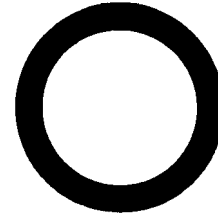

DA10017G

Green O-Ring;
Ford Service Valve;

COUPLING SPRINGS

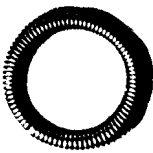

DA257213

#6 Ford Spring;
Coupling Spring;

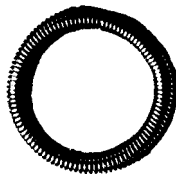

DA257214

#8 Ford Spring;
Coupling Spring;

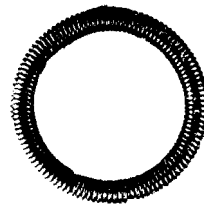

DA257215

#10 Ford Spring;
Coupling Spring;

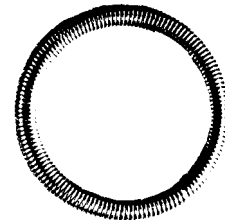

DA257216

#12 Ford Spring;
Coupling Spring;



DEALER PRODUCTS, INC.

“O”-RING ASSORTMENTS

MU15 or MU15B “Blue” General Motors O-Ring Kit

Contents:

2-DA357008, 4-DA10006, 2-DA10008, 3-DA10010, 2-DA10012, 2-DA10017

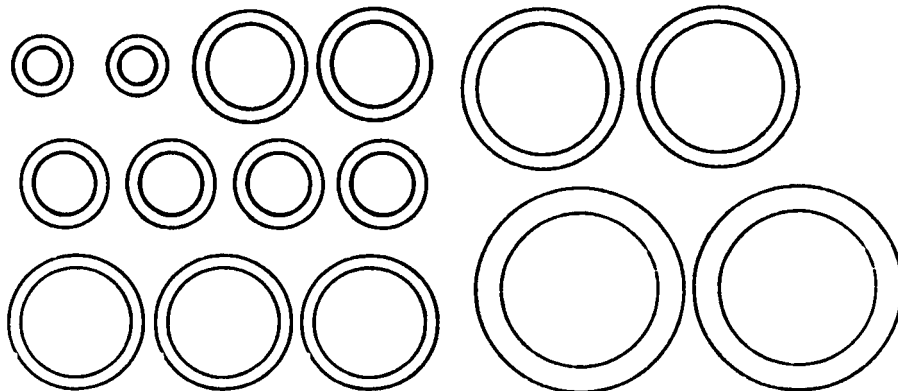

MU16 or MU16B “Blue” LATE GENERAL MOTORS O-RING KIT



DA257008

Tube Seal
Qty = 2



DA10006

#6 Hose Fitting
Qty = 2



DA10008

#8 Hose Fitting
Qty = 2



DA10010

#10 Hose Fitting
Qty = 2

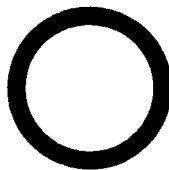

DA10012

#12 Hose Fitting
Qty = 3

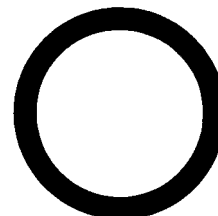

DA10021

Service Valve Seal
Qty = 2



DEALER PRODUCTS, INC.

“O”-RING ASSORTMENTS

MUKTFSLG (Green) Ford O-Ring Kit

Contents: 1-DA257213, 1-DA257214, 1-DA257215, 1-DA256216, 2-DA257204,
2-DA257205, 2-DA257206, 2-DA257207

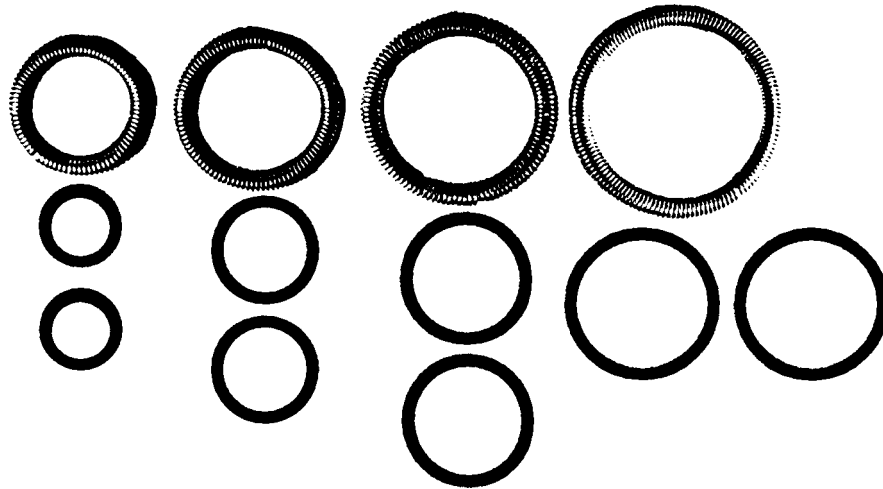

DA251272

Ford Spring Lock Coupling Assortment

O-Ring Description	Qty Pkg
3/8" Coupling O-Ring #6 Green	10
1/2" Coupling O-Ring #8 Green	10
5/8" Coupling O-Ring #10 Green	10
3/4" Coupling O-Ring #12 Green	10
#6 Coupling Spring	5
#8 Coupling Spring	5
#10 Coupling Spring	5
#12 Coupling Spring	5

COMES IN 8 COMPARTMENT PLASTIC BOX

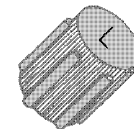

SACP653

BLUE R-134A 13mm
Low Side Plastic Valve
Cap w/ Neoprene Seal;
Fits OEM & After Market
Type R-134A Ports;

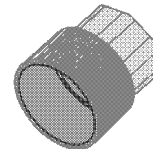

SACP654

Red R-134A 16mm High
Side Plastic Valve Cap w/
Neoprene Seal; Large Cap;
Fits OEM & After Market
Type R-134A Ports;



DEALER PRODUCTS, INC.







“O”-RING ASSORTMENTS

DA10005

GM Dual O-Ring/Gasket Kit (Blue Neoprene)

All Items are Quantities of 10 Except as Noted

*R-12, R-134a
Compatible!*

 MG-454 No. 8 1/2" Dual O-Ring Backup Metal Gasket GM #52460714 (20 Per)	 MG-455 No. 10 5/8" Dual O-Ring Backup Metal Gasket GM #52460715 (20 Per)	 MG-456 No. 12 3/4" Dual O-Ring Backup Metal Gasket GM #52460716 (20 Per)
 -955MDBlue No. 8 1/2" Dual O-Ring GM #52458087	 -515DBlue No. 10 5/8" Dual O-Ring GM #52458068	 -640DBlue No. 12 3/4" Dual O-Ring GM #52456060



SELECT BLUE "O"-RINGS



DA10006B

#6 Blue Hose Fitting; VIR Pickup Tube; Nissan #10 Hose Fitting/ Drier O-Ring/Ford Expansion Valve Seal/DA-6 Discharge; Cross Over Seal;



DA10008B

#8 Blue Hose Fitting; GM V-5 Control Valve Seal/Nissan #12 Hose Fitting; Concenser Discharge Line Seal/VIR Evaporator Inlet Line Connection;



DA10010B

#10 Blue Hose Fitting Seal; York/Tecumseh Tube-O Valve Seal; Nissan Evaporator Suction Line O-Ring;

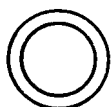

DA257012B

GM Cycling Switch O-Ring; Blue;



DA10012B

#12 Blue Hose Fitting Seal /VIR Expansion Valve Seal (Lower); VIR Evaporator Outlet Seal; VIR Connection to Evaporator Suction Line Seal; GM V-5 Control Valve Seal;

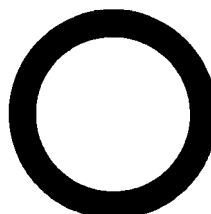

DA10017B

Blue O-Ring - GM Service Valve;

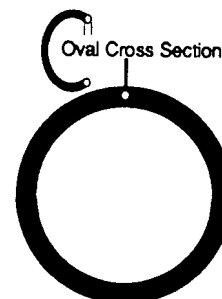

DA10021B

Blue O-Ring - GM Service Valve; Late Models;



DA10604B

Blue Ford Expansion Valve Seal; Alternate #6 GM Captured Fitting Seal;



DA10607B

Blue Alternate #8 Captured Fitting Seal;



DA10608B

DA-6 EARly Shaft Seal O-Ring; Alternate #10; GM Captured Fitting Seal;

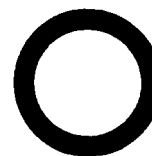

DA10113B

Blue GM A-6A/R-4 Carbon Seat Seal; #12 GM Captured O-Ring;

 **DEALER PRODUCTS, INC.** 
NOTES



DEALER PRODUCTS, INC.

STRATOFLEX FREON HOSE

GROUP XV



255 HOSE

Hose Construction: A Seamless Rubber Inner Tube, Reinforced with Two Fabric Braids and Covered with a Weather, Oil, and Abrasion Resistant Synthetic Rubber Cover, Which is Perforated to Resist Blisters.

Uses: Specifically Designed for Automotive and Commercial Lines Carrying Freon 12.

Temperatures: -20° F through +250° F

DPI Number	Hose Size	Hose I.D.	Hose O.D.	Min Burst Pressure	Max Working Pressure	Min Bend Radius
SF2556	6	5/16"	.795"	1750 PSI	400 PSI	4.00
SF2558	8	13/32"	.91"	1750 PSI	400 PSI	5.00
SF25510	10	1/2"	1.00"	1750 PSI	400 PSI	6.00
SF25512	12	5/8"	1.13"	1750 PSI	400 PSI	6.00



DEALER PRODUCTS, INC.

MISCELLANEOUS AIR CONDITIONING PARTS

CIB500

Not Supplied by OEM, Replacement A/C - Heat Blower Motor Brush Kit. Replacement Kit Fits:

1986-90	Acura Integra & Legend
1985-89	Chev. Nova & Spectrum
1980-88	Honda
1987-90	Sterling
1985-89	Isuzu I-Mark
1986-89	Mazda 323
1982-85	Mazda RX-7
1990-92	Mazda 626
1986-90	Mazda Pickup
1987-90	Ram D 50
1980-88	Subaru
1986-90	Suzuki
1980-87	Toyota
	Daihatsu

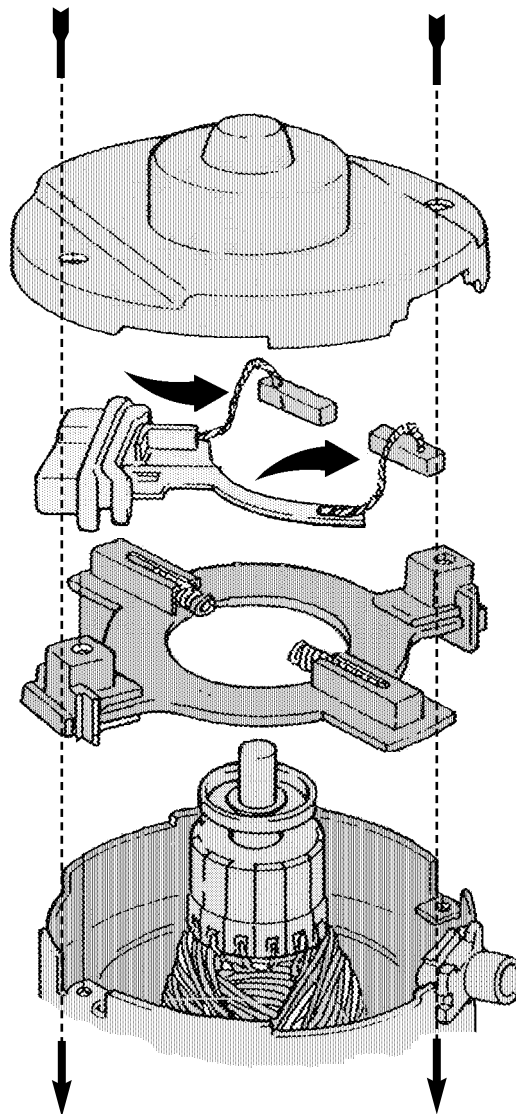



DEALER PRODUCTS, INC.

MISCELLANEOUS AIR CONDITIONING PARTS



DA30001

Clutch Bearing;
GM A-6, R-4, DAS;



DA60100

Insulation Tacky Tape;

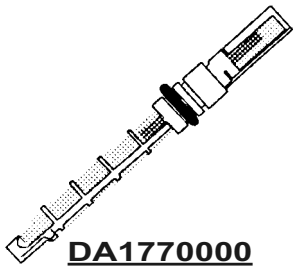

DA1770000

GM Orifice Tube;

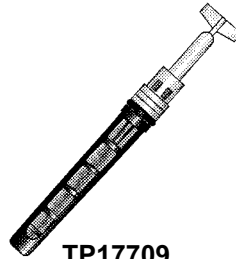

TP17709

GM A/C Orifice Tube;
Black/White or Red/White;
Orifice Size: .072";
Replaces 3096068, 15-5378;
1 Black O-Ring (T-Top);
For GM, Opel/Vauxhall, Volvo;

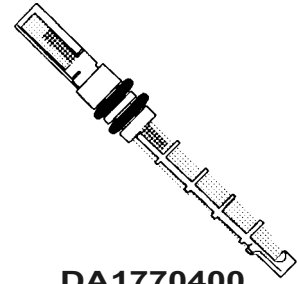

DA1770400

Ford Orifice Tube



DA256128

Schrader Valve Core;



DA13737

3/16" Plastic Valve Cap;



TP13992

1/4" Plastic Valve Cap;



DEALER PRODUCTS, INC.

MISCELLANEOUS AIR CONDITIONING PARTS

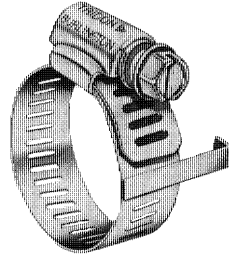

AIR CONDITIONING CLAMPS
With Locator Bar for Correct
Positioning

DPI Number	Minimum Diameter	Maximum Diameter	Normal Diameter	Fits AC Hose Size	Box Qty.
TD185008	7/16"	1"	9/16"	6-8	10
TD185010	9/16"	1-1/18"	5/8"	10	10

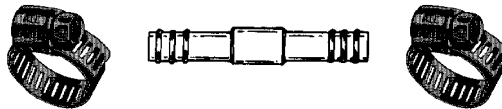

STRAIGHT AND STEP-UP SPLICE W/ CLAMPS

DPI Number	Hose Size/No.	Qty Pkg
DA20006	6 X 6	1
DA20008	8 X 8	1
DA20010	10 X 10	1
DA20012	12 X 12	1

PROPANE FUEL

BABTX8

Propane Fuel;
Bottle - 14.1 oz.

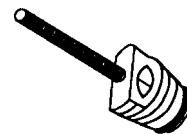

DA256150

Valve Core;
A/C Large Bore;



DEALER PRODUCTS, INC.

MISCELLANEOUS AIR CONDITIONING PRODUCTS



TC6912

Refrigeration Oil; For A/C Leaks;
Quality 500 Viscosity
Compressor Oil for Automotive
Air Conditioning Systems;
One Quart Plastic Bottle; Printed
Calibrations to Facilitate
Measured Pouring;



SA21116379

Premium Ester Lubricant for
Automotive Air Conditioning
Systems;
For HFC-134A Retro Fits;
Viscosity ISO 100, 500 SUS
@ 100 deg. F;
8 ounce Bottle;



TC6545

A/C Flush Solvent;
32 Fl. Ounces

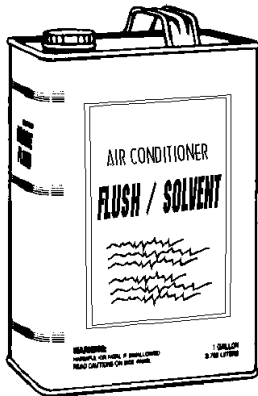

DA40251

Flush - Solvent for Air Conditioners;
R-12, 1 Gallon;



EF305D

R-134A Total Treatment with
Lock-On Dispenser - 5.25 oz.
Contains all the chemicals
needed to tune up an A/C sys-
tem. Contains 2 Oz. of 134A
refrigerant, 2 Oz. of PAG oil,
and 1 Oz. of Cool Down.
12 per package



EF313D

R-134A Cool Down with Lock-
On Dispenser;
Contains chemicals that
improve A/C cooling up to
10°. The Chemicals reduce
friction for better compressor
performance and evaporation;
12 per package



SG3C

White "Smoke" Bomb;
Use Inside Refrigerated
Trailers to Find Leaks;



EF760

Auto A/C Odor Out - 7.25 Oz;
Eliminates odors caused by
mold, mildew, smoke, bacteria,
algae, and cigarette smoke;
Uses a flexible dispensing
hose to get inside the A/C
intake ducts and outside air
vents; Fresh Vanilla scent;
12 per package



FR1296

FR-12/R-416A Refrigerant;
Sold By The Case Only
12 cans per case





















DEALER PRODUCTS, INC.

R-12 Only

DA251877

General Motors Assortment

 DA257008 -008 GM Capillary Tube Seal	 -011 DA10006 No. 6 Hose Fitting Seal	 -013 DA10008 No. 8 Hose Fitting Seal	 -015 DA10010 No. 10 Hose Fitting Seal	 -017 DA10012 No. 12 Hose Fitting Seal	 -211 DA10017 A6 / DA6 / HR6 / V5 Service Valve Seal
 DA10604 -108 No. 6 Captive Fitting Seal	 DA10607 -110 No. 8 Captive Fitting Seal	 -112 DA257112 No. 10 Captive Fitting Seal	 -113 DA10113 No. 12 Captive Fitting Seal	 -118 DA257118 Switch Port Seal	 -212 DA10021 R4 Service Valve Seal
 DA256132 DA256131 LC-108 MC-524 Charging Hose Gasket / Valve Core Depressor (1/4") (5 each)	 TP256146 LC-109 MC-525 Charging Hose Gasket / Valve Core Depressor (3/16") (5 each)	 LC-110 Top Can Tap Gasket (5 per)	 DA256128 MC-528 Refrigeration Valve Core (5 per)	 DA256150 MC-565 Large Bore Valve Core (3 per)	 DA13737 TP13992 CP-605 CP-616 Plastic Valve Port Caps (3/16" & 1/4") (3 each)

All Items are Quantities of 10 Except Where Noted

DA251877 Cross-Over Chart TAAP / SUN AIR

(order from this column)

(order from this column)

DPI Number TAAP	Cross-Over Sun Air	DPI Number TAAP	Cross-Over Sun Air
DA257008	008	DA10021	212
DA10006	011	DA256132	LC108
DA10008	013	DA256131	MC524
DA10010	015	TP256146	LC109
DA10012	017	*MC525	MC525
DA10017	211	*LC110	LC110
DA10604	108	DA256128	MC528
DA10607	110	DA256150	MC565
DA257112	112	DA13737	CP605
DA10113	113	TP13992	CP616
DA257118	118		

"*" Indicates Items With No Cross-Over



DEALER PRODUCTS, INC.

R-12, R-134a
Compatible!

DA261274 Metric / Import O-Ring Assortment (Neoprene)

 DA267012 -012N Compressor Switch Port / Oil Plug O-Ring	 DA267013 -013N No. 8 Hose Fitting O-Ring	 DA267015 -015N No. 10 Hose Fiting O-Ring	 DA267906 -005TN No. 5 (7MM) Toyota Fitting O-Ring
 DA267901 -901N Nissan No. 6 Hose Fitting Expansion Valve O-Ring	 DA267010 -010N Nissan No. 8 Hose Fitting Drier O-Ring	 DA267011 -011N Nissan No. 10 Hose Fitting Drier O-Ring	 DA267113 -113N Nissan No.12 Hose Fitting / Condenser O-Ring
 DA267015 -015N Nissan Evaporator Suction Line O-Ring	 DA267111 -111N Nissan Condenser Liquid Line O-Ring	 DA267013 -013N Nissan Compressor Flange O-Ring	 DA267116 -116N Nippondenso Service Valve O-Ring

All Items are Quantities of 10 Except Where Noted

DA261274 Cross-Over Chart TAAP / SUN AIR

(order from this column)

DPI Number TAAP	Cross-Over Sun Air
DA267012	012N
DA267013	013N
DA267015	015N
DA267906	005TN
DA267901	901N
DA267010	010N
DA267011	011N
DA267113	113N
DA267015	015N
DA267111	111N
DA267013	013N
DA267116	116N



DEALER PRODUCTS, INC.

R-12, R-134a
Compatible!

MUGMA24B GM Service Assortment

 DA267008 -008Blue Expansion Valve Capillary O-Ring	 DA10006B -011Blue No. 6 Hose Fitting / Drier O-Ring	 DA257012B -012Blue Pressure Relief / V5 Control Valve O-Ring	 DA10008B -013Blue No. 8 Hose Fitting / Drier / V5 Control Valve O-Ring	 DA10010B -015Blue No. 10 Hose Fitting O-Ring	 DA10012B -017Blue No. 12 Hose Fitting / V5 Control Valve O-Ring
 DA10604B -108Blue No. 6 Captive O-Ring	 DA10607B -110Blue No. 8 Captive O-Ring	 DA10608B -112Blue No. 10 Captive O-Ring	 DA10113B -113Blue No. 12 Captive O-Ring	 DA10117B -211Blue Standard Service Valve O-Ring (1988 & Prior)	 DA267118 -118Blue Switch Port O-Ring
 DA10021B -211RBlue Oval Service Valve O-Ring	 DA257104 -212Blue R4 Service Valve O-Ring	 DA257104 -955MDBLue No. 8 (1/2") Dual Connection O-Ring	 DA257105 -515DBLue No. 10 (5/8") Dual Connection O-Ring	 DA257106 -640DBLue No. 12 (3/4") Dual Connection O-Ring	 DA257125 MG-454 No. 8 (1/2") Dual Connection Gasket
 DA257126 MG-455 No. 10 (5/8") Dual Connection Gasket (4 per)	 DA257127 MG-456 No. 12 (3/4") Dual Connection Gasket (4 per)	 MC-638 5/8" Thick Compressor Sealing Washer (4 per)	 MC-641 Sealing Washer Pilot	 MC-639 5/8" Thin Compressor Sealing Washer (4 per)	 MC-640 3/4" Thin Compressor Sealing Washer (4 per)

All Items are Quantities of 10 Except Where Noted

MUGMA24B Cross-Over Chart TAAP / SUN AIR

(order from this column)

DPI Number TAAP	Cross-Over Sun Air
DA267008	008BLUE
DA10006B	011BLUE
DA257012B	012BLUE
DA10008B	013BLUE
DA10010B	015BLUE
DA10012B	017BLUE
DA10604B	108BLUE
DA10607B	110BLUE
DA10608B	112BLUE
DA10113B	113BLUE
DA10117B	211BLUE
DA267118	118BLUE
DA10021B	211BLUE

(order from this column)

DPI Number TAAP	Cross-Over Sun Air
*212B	212B
DA257104	955MDBLUE
DA257105	515DBLUE
DA257106	640DBLUE
DA257125	MG454
DA257126	MG455
DA257127	MG456
*MC638	MC638
*MC641	MC641
*MC639	MC639
*MC640	MC640

“*” Indicates Items With No Cross-Over



DEALER PRODUCTS, INC.

A/C Retro Kits



DAFORF1

FORD R-134A Retro Kit;

For Converting R-12 A/C Systems to
Environmentally Safe HFC-134A;

Includes O-Rings, Connections, Lubricant,
and Notice Labels;



DEALER PRODUCTS, INC.

A/C Retro Kits



DA21400

GENERAL MOTORS R-134A Retro Kit;
For Converting R-12 A/C Systems to
Environmentally Safe HFC-134A;
Includes O-Rings, Connections, Lubricant,
and Notice Labels;



DEALER PRODUCTS, INC.

A/C Retro Kits



DA21403

CHRYSLER R-134A Retro Kit;
For Converting R-12 A/C Systems to
Environmentally Safe HFC-134A;
Includes O-Rings, Connections, Lubricant,
and Notice Labels;



DEALER PRODUCTS, INC.

R-134a RETRO FIT ADAPTERS

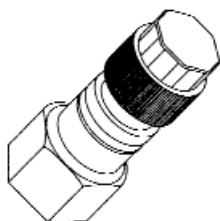

DP091995M
R-134A Retro Fit Adapter;
Red Cap; Straight 16mm (1/4")
Adapter Fitting; Size: 16mm;
Thread: 7/16" X 20 (1/4"); Steel;
Includes Cap, Valve Core,
Neoprene O-Ring and
Threadlock;

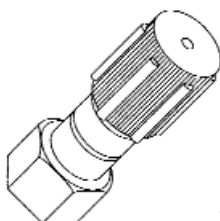

DP091996M
R-134A Retro Fit Adapter;
Blue Cap; Straight 13mm (1/4")
Adapter Fitting; Size: 13mm;
Thread: 7/16" X 20 (1/4"); Steel;
Includes Cap, Valve Core,
Neoprene O-Ring and
Threadlock;

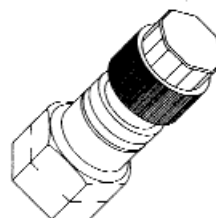

DP091997M
R-134A Retro Fit Adapter;
Red Cap; Straight 16mm (3/16")
Adapter Fitting; Size: 16mm;
Thread: 3/8" X 24 (3/16"); Steel;
Includes Cap, Valve Core,
Neoprene O-Ring and
Threadlock;

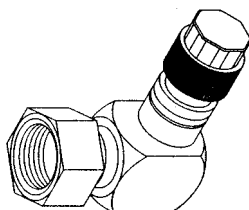

DP091953M
R-134A Retro Fit Adapter;
Red Cap; 90 Deg. 16mm (1/4")
Adapter Fitting;
Size: 16mm; Thread: 7/16" X 20
(1/4"); Steel; Includes Cap,
Valve Core, Neoprene O-Ring
and Threadlock;

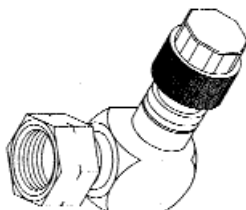

DP091954M
R-134A Retro Fit Adapter;
Blue Cap; 90 Deg. 13mm (1/4")
Adapter Fitting;
Size: 13mm; Thread: 7/16" X 20
(1/4"); Steel; Includes Cap,
Valve Core, Neoprene O-Ring
and Threadlock;

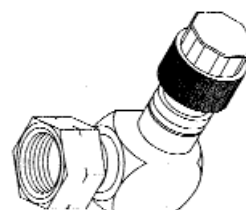

DP091955M
R-134A Retro Fit Adapter;
Red Cap; 90 Deg. 13mm (3/16")
Adapter Fitting;
Size: 16mm; Thread: 3/8" X 24
(3/16"); Steel; Includes Cap,
Valve Core, Neoprene O-Ring
and Threadlock;

NOTICE: RETROFITTED to R-134 a
Retrofit procedure performed to SAE J1661
CAUTION: System to be serviced by qualified personnel only.

Retrofit Date: _____
Name of company or individual performing retrofit: _____
Address: _____
City / State _____ Zip _____
Tel # _____ R-134a Charge _____
Lubricant Type _____ Lubricant Amount _____
Auxiliary Label Location: _____

DP09200

Retro-Fit Add-On Labels