

TIRE PRODUCTS

SECTION "K"

DEALER PRODUCTS, INC
1185 108TH ST.
GRAND PRAIRIE, TX 75050
800-999-8828





Section “K”

INDEX

DEALER PRODUCTS, INC
1185 108TH ST.
GRAND PRAIRIE, TX 75050
800-999-8828

“K” SECTION

INDEX

<u>Part Description</u>	<u>Page #</u>
Brake Lathe Bits	K-013
Caster/Camber Adjustment Cam	K-021
Caster/Camber Bushings	K-018 - K-019
“Camel” Tire Repair Products	K-023
“KEX” Tire Repair Products	K-022, K-024, K-025
Perfect Wheel Weights	
AW Type	K-002
CT Type	K-005
EN Type	K-006
FN Type	K-006
FSGET Type	K-010
IAL Type	K-009
IAW Type	K-003
LH Type	K-009
LT1 Type	K-005
MC Type	K-004
P Type	K-001
Pre-Taped/Adhesive	K-008
TAL Type	K-005
Shims	
Camber/Caster	K-011 - K-012
Rear Wheel	K-014, K-016
Truck	K-015
4 X 4’s	K-017
Tire (Stems & Accessories)	K-028
Tools	
Installation Tools	K-007
Gauges	K-026
Valves	K-027



DEALER PRODUCTS, INC.

PERFECT WHEEL WEIGHTS

SNUGL WEIGHTS

WEIGHTS FOR ALUMINUM WHEELS

Perfect/SNUGL Weights for Aluminum Wheels have the Special "Window Barb" Clip Design. Since Aluminum is Soft, the Tire has a Tendency to "Push" the Weight off the Wheel. This is Not Possible with the Unique Clip-On Barb Design on these Weights.



"P" Type (1000 Series - SNUGL)

For Use on All Passenger Car Rims with 13"-15" Wheels Except Where Full Flush Wheel Covers may Require the "CAX" Type Shown Below. The Perfect and ** SNUGL Design Use a "Dovetail" Clip to Insure Double Retention of the Clip to the Wheel. All Clips are Mechanically Plated and Batch Tested in Salt Spray Tests to Assure Rust Free Performance Demanded by OEM Engineers. Passenger Weights for Steel Wheels have a Red Strip on the Label for Product Group Identification.

DPI Number	Weight Size	Qty Pkg
PWP025	1/4 oz	50
PWP050*	1/2 oz	50
PWP075	3/4 oz	50
PWP100	1 oz	50
PWP125	1-1/4 oz	50
PWP150*	1-1/2 oz	50
PWP175	1-3/4 oz	50
PWP200	2 oz	50
PWP225*	2-1/4 oz	50
PWP250	2-1/2 oz	50
PWP275	2-3/4 oz	50
PWP300	3 oz	50
PWP325	3-1/4 oz	25
PWP350	3-1/2 oz	25
PWP375	3-3/4 oz	25
PWP400	4 oz	25
PWP450	4-1/2 oz	25
PWP500	5 oz	25

* Weights for Static Bubble Balance



DEALER PRODUCTS, INC.

PERFECT WHEEL WEIGHTS



“AW” Type

Weights for Alloy Wheels. OEM Application, all Chrysler Products, all GM Products except Trans-Am and Corvette. All Ford Products '75-'79. Most Models '80-'83. After-Market Application. Fits Many Major Aftermarket Manufacturers 13”, 14” and 15” Passenger Car Alloy Wheels such as Shelby, Superior, Appliance, Keystone, and Cragar.

“AW” Type Nylon Coated (General Motors)

DPI Number	Weight Size	Qty Pkg
PWAW025N	1/4 oz	25
PWAW050N	1/2 oz	25
PWAW075N	3/4 oz	25
PWAW100N	1 oz	25
PWAW125N	1-1/4 oz	25
PWAW150N	1-1/2 oz	25
PWAW175N	1-3/4 oz	25
PWAW200N	2 oz	25
PWAW225N	2-1/4 oz	25
PWAW250N	2-1/2 oz	25
PWAW275N	2-3/4 oz	25
PWAW300N	3 oz	25

“AW” Type Uncoated

DPI Number	Weight Size	Qty Pkg
PWAW025	1/4 oz	50
PWAW050	1/2 oz	50
PWAW075	3/4 oz	50
PWAW100	1 oz	50
PWAW125	1-1/4 oz	50
PWAW150	1-1/2 oz	50
PWAW175	1-3/4 oz	50
PWAW200	2 oz	50
PWAW225	2-1/4 oz	50
PWAW250	2-1/2 oz	50
PWAW275	2-3/4 oz	50
PWAW300	3 oz	50



DEALER PRODUCTS, INC.

PERFECT WHEEL WEIGHTS



“IAW” Type (Coated)

Weights for Import Alloy Wheels. This Series is Treated with a Special Plastic Coating Material that is Harder than Lacquer, to Protect the Wheel. OEM Application - Datsun/Nissan, Toyota, Mercedes, Volvo, BMW, and Porsche. Note: May Not Fit some Early Models. Aftermarket Application - Will fit Exim, Ronal. Will Not Fit BBS, Enkie, and Epsilon.

DPI Number	Weight Size	Weight In Grams	Qty Pkg
PWIAW005	1/8 oz	05	25
PWIAW010	1/4 oz	10	25
PWIAW015	1/2 oz	15	25
PWIAW020	3/4 oz	20	25
PWIAW025	7/8 oz	25	25
PWIAW030	1 oz	30	25
PWIAW035	1-1/4 oz	35	25
PWIAW040	1-3/8 oz	40	25
PWIAW045	1-1/2 oz	45	25
PWIAW050	1-3/4 oz	50	25
PWIAW055	2 oz	55	25
PWIAW060	2-1/4 oz	60	25



PERFECT WHEEL WEIGHTS



“MC” Type

Weights for Alloy Wheels. OEM Application - Ford Products 1979 and Later Mustang and Capri. 1980 and Later Cougar and T-Bird. 1981 through 1983 Models are Constantly being Changed from AW Type Rims to MC Type Rims. All 1984 Ford Products. Aftermarket Application - 3/4 Ton, 16 X 6k Steel Wheels with Curved Flange.

“MCN” Type Nylon Coated (Ford)

DPI Number	Weight Size	Qty Pkg
PWMC025N	1/4 oz	25
PWMC050N	1/2 oz	25
PWMC075N	3/4 oz	25
PWMC100N	1 oz	25
PWMC125N	1-1/4 oz	25
PWMC150N	1-1/2 oz	25
PWMC175N	1-3/4 oz	25
PWMC200N	2 oz	25
PWMC225N	2-1/4 oz	25
PWMC250N	2-1/2 oz	25
PWMC275N	2-3/4 oz	25

“MC” Type Uncoated

DPI Number	Weight Size	Qty Pkg
PWMC025	1/4 oz	50
PWMC050	1/2 oz	50
PWMC075	3/4 oz	50
PWMC100	1 oz	50
PWMC125	1-1/4 oz	50
PWMC150	1-1/2 oz	50
PWMC175	1-3/4 oz	50
PWMC200	2 oz	50
PWMC225	2-1/4 oz	50
PWMC250	2-1/2 oz	50
PWMC275	2-3/4 oz	50
PWMC300	3 oz	50



PERFECT WHEEL WEIGHTS

DPI Number	Weight Size	Qty Pkg
PWLT1005	1/2 oz	25
PWLT1010	1 oz	25
PWLT1015	1-1/2 oz	25
PWLT1020	2 oz	25
PWLT1030	3 oz	25
PWLT1035	3-1/2 oz	25



“LT1” Type

Used Basically on Light-Duty Trucks, 3/4 and 1 ton Vehicles with Either Tube Type or Tubeless Rims where Such Rims are Too Thick for Passenger Weights. Also for Use on Heavier Trucks with Thin Rim Flanges.

Note: Use “P” Type Weights on 1/2 Ton Vehicles.



Closed Side



Open Side

“TAL” Series - Wheel Protectors

Coated Wheel Weights

A Special Weight for All Alcoa and Accuride (from 1983) Aluminum Tubeless Heavy Truck Wheels. The Weights will fit Both Sides of the Wheel. These Weights Replace the “OS-TAL” and “DS-TAL” Series. Use Rim Gauge to Verify Correct Application (Either OS-TAL or DS-TAL Slot).

DPI Number	Weight Size	Qty Pkg
PWTAL040	4 oz	25
PWTAL060	6 oz	25
PWTAL080	8 oz	25

DPI Number	Weight Size	Qty Pkg
PWCT020	2 oz	25
PWCT040	4 oz	25
PWCT060	6 oz	25
PWCT080	8 oz	25
PWCT100	10 oz	20



“CT” Type

Used on Heavy-Duty Trucks with Firestone, Budd or Goodyear Tubeless Rims (Except Steel Rims with Curved Edges). Used Mostly on Rim Widths 6.75, 7.50, and 8.25.



DEALER PRODUCTS, INC.

PERFECT WHEEL WEIGHTS

“EN” Type

Wheel Protector Coated Wheel Weights.
Applications: Honda and Acura with Alloy
Wheels. Also Used on Vehicles Equipped
with Enkei Aftermarket Wheels. Use Rim
Gauge Number RGP! to Verify Correct
Application.

DPI Number	Weight In Grams	Qty Pkg
PWEN010	10	25
PWEN015	15	25
PWEN020	20	25
PWEN025	25	25
PWEN030	30	25
PWEN035	35	25
PWEN040	40	25
PWEN045	45	25
PWEN055	55	25
PWEN060	60	25

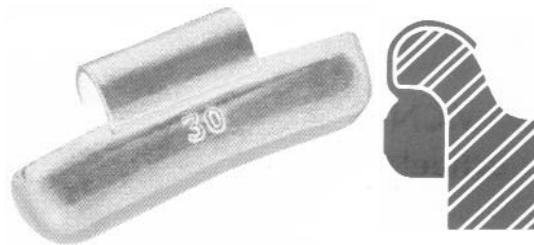
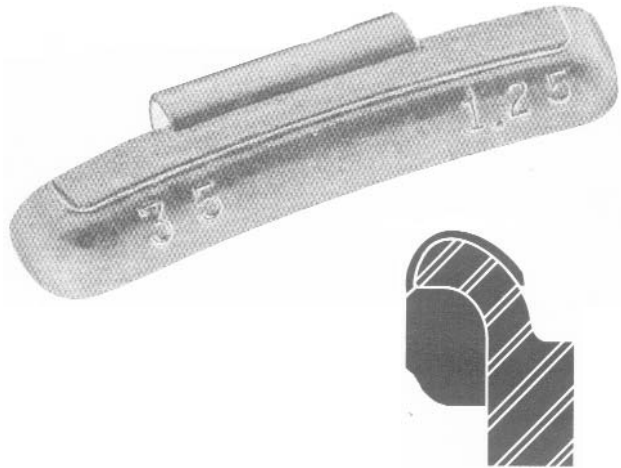

“FN” Type

As Above but Fits Acura, Geo, Honda,
Infiniti, Lexus, Nissan, and Toyota.

DPI Number	Weight In Grams	Qty Pkg
PWFN005	5	25
PWFN010	10	25
PWFN015	15	25
PWFN020	20	25
PWFN025	25	25
PWFN030	30	25
PWFN035	35	25
PWFN040	40	25
PWFN045	45	25
PWFN050	50	25
PWFN055	55	25
PWFN060	60	25

CHROME		
DPI Number	Weight In Grams	Qty Pkg
PWFN005C	5	25
PWFN010C	10	25
PWFN015C	15	25
PWFN020C	20	25
PWFN025C	25	25
PWFN030C	30	25
PWFN035C	35	25
PWFN040C	40	25
PWFN045C	45	25
PWFN050C	50	25
PWFN055C	55	25
PWFN060C	60	25



DEALER PRODUCTS, INC.

PERFECT WHEEL WEIGHTS

"T" Type

Wheel Weights for Truck Steel Wheels. Used on 1988 and Newer Domestic Light Trucks with Decorative and Larger Thickness Steel Wheels. The Special Polymer Coating Insure that these Decorative Steel Wheels are Not Damaged by Corrosion. Chevrolet '88-'95, Ford '94-'95, Dodge '93-'95.



DPI Number	Weight Size	Qty Pkg
PWT025N	1/4 oz	25
PWT050N	1/2 oz	25
PWT075N	3/4 oz	25
PWT100N	1 oz	25
PWT125N	1-1/4 oz	25
PWT150N	1-1/2 oz	25
PWT175N	1-3/4 oz	25
PWT200N	2 oz	25
PWT225N	2-1/4 oz	25
PWT250N	2-1/2 oz	25
PWT275N	2-3/4 oz	25
PWT300N	3 oz	25
PWT325N	3-1/4 oz	25
PWT350N	3-1/2 oz	25
PWT375N	3-3/4 oz	25
PWT400N	4 oz	25
PWT500N	5 oz	25

Wheel Balancing Products and Tools

PE25K

Installation Tool

This Passenger Car Wheel Weight Installation Tool is the Industry Standard. Plastic Coated Handles Provide Better Grip.

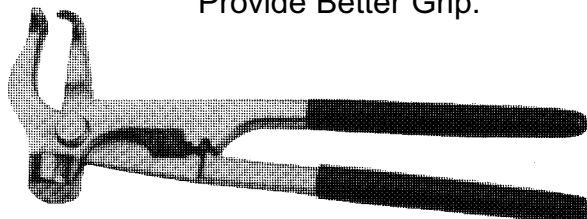



DEALER PRODUCTS, INC.

PERFECT WHEEL WEIGHTS

Pre-Taped/Adhesive Weights



QuikStik Adhesive Style Weights

Passenger Car & Motorcycle

The Only Pre-Cut, Pre-Taped Weight. With These Unique Features, There is No Cutting, No Pre-Contouring, and Waste.

Available in 1/2", 3/4" Low Profile, and 3/4" Truck Weight Design. Also Available in Chrome. QuikStik Passenger Weights Replace the Centrifugal Lock Weight Series.

PW100360

Box Contains 30-3 oz. Strips Pre-cut in 1/4 oz. (7 gram) increments of 1/2" Width.

PW100720

Box Contains 60-3 oz. Strips Pre-cut in 1/4 oz. (7 gram) increments of 1/2" Width.

PW200624

(Low Profile), Used Primarily on Imports where the Brake Caliper Knocks Off Clip-On or 1/2" Width Pre-Taped Weights.

Box Contains 52-3 oz. Strips Pre-Cut in 1/4 oz. (7 gram) increments of 3/4" Width.

QuikStik Adhesive Style Weights

Truck & R.V. Designs

Due to Popular Demand, the Pre-Cut, Pre-Taped Weight is Now Available for Truck and R.V. Use. 3/4" Width Pre-Cut in 1/2 oz.

(14 gram) Increments of 6 oz. Strips.

PW300360

Replaces Part PWCL12, PWCL12T, and PWSS12000T.



DEALER PRODUCTS, INC.

PERFECT WHEEL WEIGHTS

“LH” Series

For 1998 Dodge Intrepid, Dodge Caravan, Chrysler Concorde, Chrysler Town and Country, and Plymouth Voyager. “Required for These Vehicles.” These New Weights are Coated, Specially Contoured, and have a Unique Clip Design. These Weights are a Must to Balance Any of These Vehicles with Flange Mounted Weights.

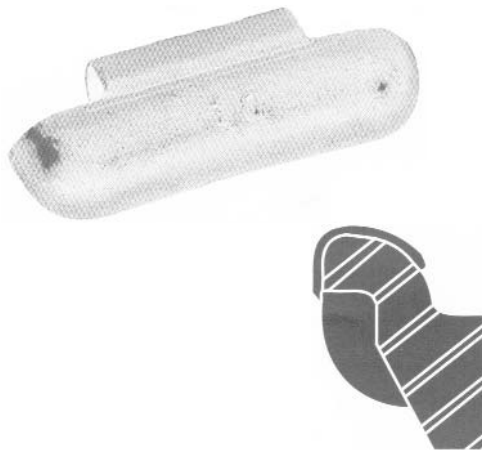

DPI Number	Weight Per Oz.	Qty Pkg
PWLH025	1/4	25
PWLH050	1/2	25
PWLH075	3/4	25
PWLH100	1	25
PWLH125	1-1/4	25
PWLH150	1-1/2	25
PWLH175	1-3/4	25
PWLH200	2	25
PWLH225	2-1/4	25
PWLH250	2-1/2	25
PWLH275	2-3/4	25
PWLH300	3	25

“IAL” Series

Imported Wheel Weights - Coated



DPI Number	Weight In Grams	Qty Pkg
PWIAL005	5	25
PWIAL010	10	25
PWIAL015	15	25
PWIAL020	20	25
PWIAL025	25	25
PWIAL030	30	25
PWIAL035	35	25
PWIAL040	40	25
PWIAL045	45	25
PWIAL050	50	25
PWIAL055	55	25
PWIAL060	60	25



DEALER PRODUCTS, INC.

PERFECT WHEEL WEIGHTS

“NTEP” Series

Aluminum Wheel Weights for
16” Truck Wheels.
Ford Trucks.

DPI Number	Weight Per Oz.	Qty Pkg
PWNTEP050	1/2	50
PWNTEP075	3/4	50
PWNTEP100	1	50
PWNTEP125	1-1/4	50
PWNTEP150	1-1/2	50
PWNTEP175	1-3/4	50
PWNTEP200	2	50
PWNTEP225	2-1/4	50
PWNTEP250	2-1/2	50
PWNTEP275	2-3/4	50
PWNTEP300	3	50

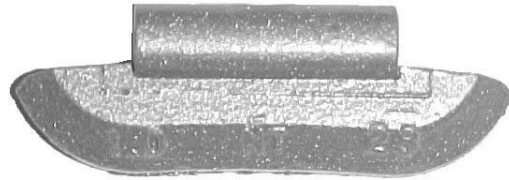

“FSGET” Series

Aluminum Wheel Weights for
2003/ Lincoln Navigator



DPI Number	Weight Per Gram	Qty Pkg
PWFSGET010	10	12
PWFSGET015	15	12
PWFSGET020	20	12
PWFSGET025	25	12
PWFSGET030	30	12
PWFSGET035	35	12
PWFSGET040	40	12
PWFSGET050	50	12
PWFSGET060	60	12
PWFSGET070	70	12
PWFSGET080	80	12
PWFSGET090	90	12
PWFSGET100	100	12
PWFSGET110	110	12
PWFSGET120	120	12
PWFSGET130	130	12
PWFSGET140	140	12



UNIVERSAL CAMBER/CASTER SHIMS

Cars & Light Trucks

DPI Number	Shim Thickness	Bolt Opening	Shim Style
PSBU030	1/32"	37/64"	BU
PSBU060	1/16"	37/64"	BU
PSBU080	3/32"	37/64"	BU
PSBU100	7/64"	37/64"	BU
PSCC132	1/32"	9/16"	CC
PSCC116	1/16"	9/16"	CC
PSCC018	1/8"	9/16"	CC
PSCT132	1/32"	17/32"	CT
PSCT116	1/16"	17/32"	CT
PSCT018	1/8"	17/32"	CT
PSCT316	3/16"	17/32"	CT
PSN164	1/64"	33/64"	N
PSN132	1/32"	33/64"	N
PSN116	1/16"	33/64"	N
PSN018	1/8"	33/64"	N
PSN316	3/16"	33/64"	N
PSUS164	1/64"	5/8"	US
PSUS132	1/32"	5/8"	US
PSUS116	1/16"	5/8"	US
PSUS018	1/8"	5/8"	US
PSX116	1/16"	7/16"	X
PSX018	1/8"	7/16"	X

Complete Shim Style Chart Page K-012

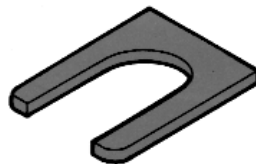

SP35062

Single Slot Tandem Truck Shim;
Changes Toe and/or Thrust
Angles; 1/8" Thick;
6 per package



DEALER PRODUCTS, INC.

UNIVERSAL CAMBER/CASTER SHIMS

Cars & Light Trucks

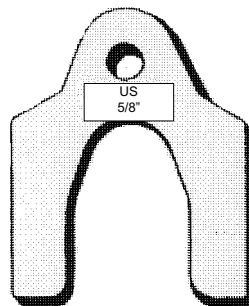
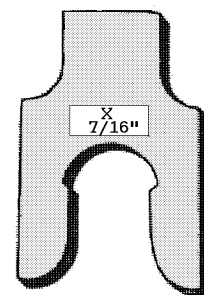
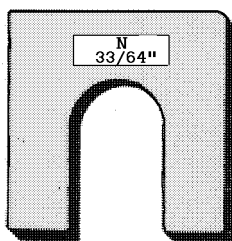
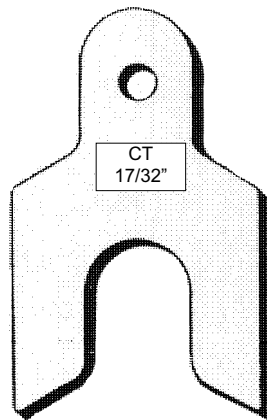
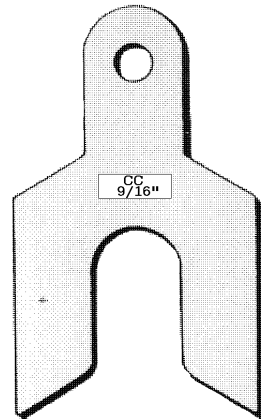
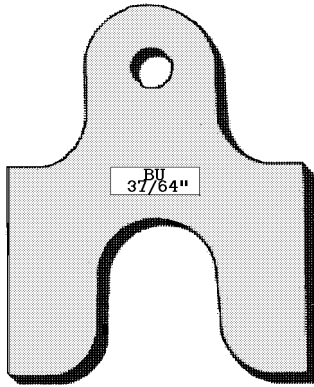



BRAKE PARTS



AMMCO BITS

For Ammco Model 3000, 4000, 4100, 6900, 7000 and 7700 Disc Rotor Lathe. Triangular Carbide. Insert # 065 Has Six Cutting Edges by Indexing the Insert.

DPI Number	Qty Pkg
SP06202	2
SP06210	10



ACCU-TURN

For Accu-Turn Disc/Drum Lathes. Triangular Carbide Insert # 060 has Three Cutting Edges.

DPI Number	Qty Pkg
SP06005	5



SP70606

Carbide Brake Lathe Insert;
Positive Rake Carbide Bit;
OEM Number: 50-701;
6 per package



SP80210

Carbide Brake Lathe Insert;
Positive Rake 15 Degree Carbide Bit;
OEM Number: SW4236-15;
6 per package



SP00069

Ventilated Disc Silencer;
Fits any ventilated Rotor and is made of Natural Rubber with Lead Weight Inserts. It easily wraps around Rotor to Deaden Vibration and Chatter.
32" Long;



SP00098

Adjustable Ventilated Rotor Silencer; Made of Latex Tubing with Lead Weight Implants;
32" Long;
1 per package



SP00080

Drum Silencer Belt;
Fits any Passenger Car Drums; Made of Natural Rubber;
Dimensions: 1-3/4" Wide, 72" Long;
1 per package

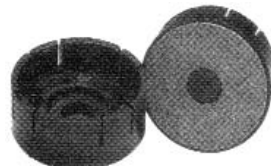

SP00083

Disc Brake Pads
Made of a tough friction substance, these replacement pads easily snap onto a Disc Rotor Silencer; They are very good for thin, non-vented type rotors on many import cars;
1 pair per package



SP00070

Brake Rotor Chatter Silencer;
Fits on Top of the Cutting Tools; Applicable on All Rotor Chatter; No Tools Needed;
1 per package



SPECIAL CAMBER/CASTER SHIMS

REAR WHEEL ALIGNMENT SHIMS

Unique Anti-Slip Design Allows Adjustment of Camber, Toe, or Combination of Both. The Most Economically Designed Rear Wheel System for GM, Chrysler, and VW Vehicles. Ford Shims Allow for Camber Adjustment Only.

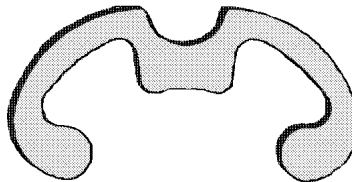

GM "X" and "J" Car Rear Wheel Shims

Camber/Toe Adjustment of Rear Wheel on X Body and J Body Vehicles

DPI Number	Camber Deg. Change	Toe Change	Qty Pkg
PSGMR010	1/4	1/16"	25
PSGMR015	3/8	3/32"	25



Chrysler and VW Rear Wheel Shims

Fits Rear Wheels on VW-Dasher, Rabbit, Scirocco; Chrysler-Omni, Horizon, and "K" Cars. Allows Camber or Toe Adjustment.

DPI Number	Camber Deg. Change	Toe Change	Qty Pkg
PSCR010	1/4	1/16"	25
PSCR015	3/8	3/32"	25



DEALER PRODUCTS, INC.

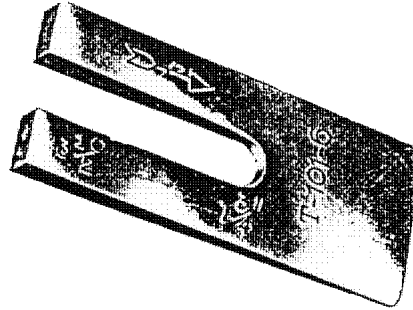

HEAVY-DUTY TRUCK SHIMS

Aluminum Alloy Truck Shims

Perfect Aluminum Alloy Truck Shims are Made from a Special Tough Aluminum Alloy, and are, therefore, Very Economical.

DPI Number	Shim Width	Shim Length	Deg. Change	Qty Pkg.
PST1041AL	2-1/2"	5"	1	25
PST1043AL	2-1/2"	5"	2	25
PST1044AL	2-1/2"	5"	2-1/2	25
PST1051AL	3"	6"	1	25
PST1052AL	3"	6"	1-1/2	25
PST1053AL	3"	6"	2	25
PST1071AL	4"	6-1/2"	1	25
PST1075AL	4"	6-1/2"	3	25

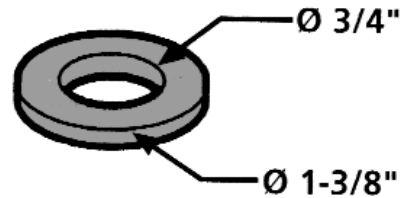
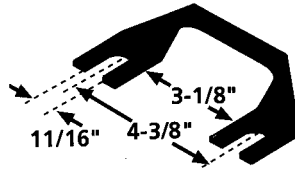

HEAVY-DUTY TRUCK SHIMS

I.H.C. Torque Arm Shims

DPI Number	Shim Width	Qty Pkg.
SP35040	1/32"	6
SP35041	1/16"	6
SP35042	1/8"	6

Heavy Duty Tandem Truck Shims
Kenworth Air Glide Spacers for "Eight Baggers"

Part Number	Thickness	Qty
SP35002	1/32"	6
SP35003	1/8"	6
SP35004	1/4"	6
SP35005	1/2"	6



DEALER PRODUCTS, INC.

REAR WHEEL TOE/CAMBER SHIMS FOR FRONT WHEEL DRIVE CARS

These Rear Wheel Alignment Shims are Available for Most GM and Chrysler Front Wheel Drive Cars. Dealer Products Carries Two Series, Each with Three Different Tapers Affording a Multitude of Toe, Camber or Simultaneous Toe/Camber Adjustments, Using Only One Shim per Wheel.

Anti-Corrosive, Precision-Engineered Tough Aluminum Alloy Shims are Designed for Quick, Easy Installation. These Tapered Shims Lock Firmly in Place and Will Not Shift. Increase Your Profits by Saving Time and Insuring Accuracy.

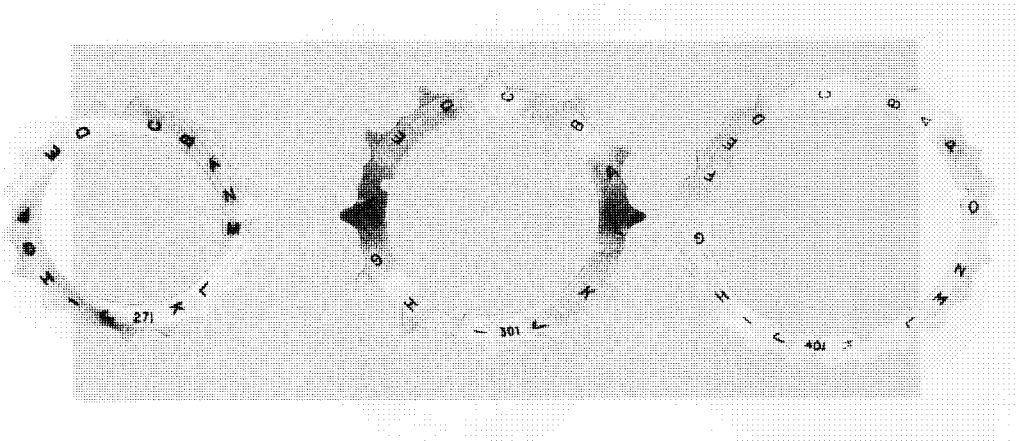

Series #300

Part #SH301 through Part #SH302
Individually Packaged Shims (Patented)

- > **Buick:** Skylark, Skyhawk, Somerset, Regal.
- > **Cadillac:** Cimmaron.
- > **Chevrolet:** Citation, Cavalier, Corsica, Beretta.
- > **Oldsmobile:** Omega, Firenza, Calais.
- > **Pontiac:** Phoenix, J2000, Grand Am, Sunbird.

SH301, SH302

 **DEALER PRODUCTS, INC.** 
NOTES



DEALER PRODUCTS, INC.

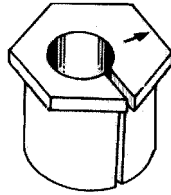

FORD 2 WHEEL DRIVE AND 4 WHEEL DRIVE CAMBER/CASTER SLEEVES

Camber and/or Caster Adjusters Give a Smaller Degree of Change on Downsize Ford 4x4's than on 4x2 Trucks.

2WD Applications Include: 1987-95 F150, F250, F350, 1989-95 Bronco II and Ranger, 1991-94 Explorer & Mazda Navajo, B2000.

4WD Applications Include: 1990-95 Bronco II & Ranger, 1991-94 Explorer & Mazda Navajo, B4000.

DPI Number	2WD Adjustments	4WD Adjustments
SP23181	.25 Deg.	.20 Deg.
SP23182	.50 Deg.	.40 Deg.
SP23183	.75 Deg.	.60 Deg.
SP23184	1.00 Deg.	.75 Deg.
SP23185	1.25 Deg.	.90 Deg.
SP23186	1.50 Deg.	1.10 Deg.
SP23187	1.75 Deg.	1.30 Deg.
SP23188	2.00 Deg.	1.50 Deg.
SP23189	2.25 Deg.	1.75 Deg.
SP23190	2.50 Deg.	2.00 Deg.

Handy Crossover Chart: "NS" to "SP"	
NS42901	SP23181
NS42902	SP23182
NS42903	SP23183
NS42904	SP23184
NS42905	SP23185
NS42906	SP23186
NS42907	SP23187
NS42908	SP23188
N/A	SP23189
N/A	SP23190

FORD AND DODGE CAMBER/CASTER SLEEVES

Ford 4WD Applications Include: 1992-up F350 Crew Cab Pickup, Some F250 4WD with Straight Axle;

Dodge Applications Include: 1994-up BR2500 4WD, BR3500 2WD/4WD;

DPI Number	2WD Adjustments
SP23131	.25 Deg.
SP23132	.50 Deg.
SP23133	.75 Deg.
SP23134	1.00 Deg.
SP23135	1.25 Deg.
SP23136	1.50 Deg.

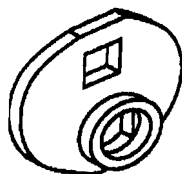

SP87310

Camber/Caster Kit (4 Adjusters);

Ford Explorer '95/;

1 per package

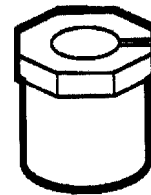

SP23192

Ford 2WD and 4WD Camber/Caster Sleeve;

3° Total change on 2WD, 2.25° on 4WD;

Ford and Mazda 2WD and 4WD;

1 per package



DEALER PRODUCTS, INC.

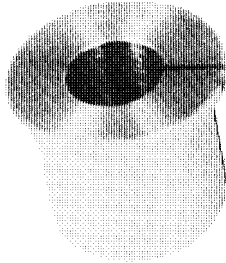

CAMBER BUSHINGS

For 1982-86 Ford 2WD Trucks

These Offset-Hole Steel Bushings Replace the Original Factory Upper Ball Joint Bushings. The Series No. 420 Bushings Provide 4 Different Plus or Minus Camber Adjustments for the Front Wheels of Ford F100, F150, and Ranger 2WD Pick-up Trucks with Independent Ball Joint Type Suspension.

DPI Number	Degree Adjustment
SH428	2 Deg.



SP23144

Yellow Ford 4WD Camber/Caster Sleeve Sets; 1 Degree Change; By installing, you can change camber, caster, or both at the same time; Dodge '94-'99; Ford 2WD, 4WD '80/; 1 per package

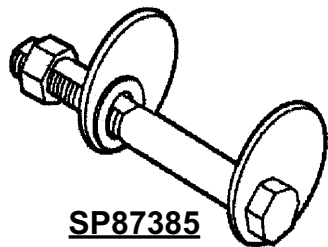

SP87385

Camber Bushings

For 1982-86 Ford 2WD Trucks

Use this New Kit to Change Caster and/or Camber on the New F150, F250 (L/D), Expedition, and Navigator. Merely Replace the Existing Upper Control Arm Mounting Bolts with these Cam Bolts for Caster/Camber changes up to 2.0°. One Kit covers both sides of the Vehicle.

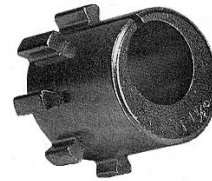

FORD 4WD CAMBER/CASTER SLEEVE SETS

23100 Series

By Installing the #23100 Series Sleeves you can Change Camber, Aster, or Both at the Same Time. Simply Remove the Tire, Cotter Pin, and Upper Ball Joint Stud Nut and Break the Taper Free Between the Stud and Sleeve.

DPI Number	Total Degree Change
SP23101	.25
SP23102	.50
SP23103	.75
SP23104	1.00
SP23105	1.25
SP23106	1.50
SP23107	1.75
SP23108	2.00
SP23109	0.00



SP87400

GM 2WD and 4WD Camber/Caster Kit; Provides up to 2° Positive or Negative Camber/Caster Adjustment; 4 per kit



SP87500

Ford Explorer Camber/Caster Kit; Provides up to 2° Positive or Negative Camber/Caster Adjustment; 4 per kit





DEALER PRODUCTS, INC.

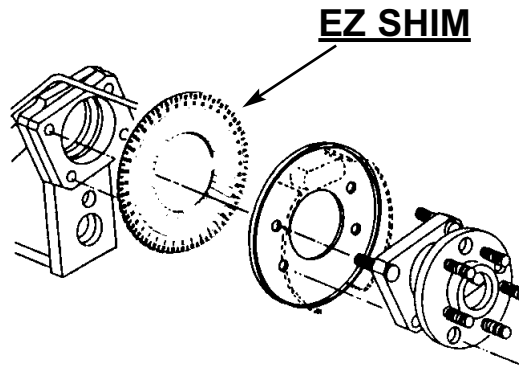

FULL CONTACT DUAL ANGLE “EZ SHIMS”

Blue, Grey, Red

Adjusts Camber and Toe with Only One Shim. Available Individually. Instruction Sheets are Included on All Dual Angle Shim Boards. Estimated Installation Time is 30 Minutes per Side.

PART NUMBER AND APPLICATIONS

SP75200 “BLUE”

Audi: Fox, 4000; **Chevrolet/Geo:** Spectrum; **Chrysler:** E-Class, Executive Sedan, Fifth Avenue, Imperial, Laser, Levaron, New Yorker, Town & Country; **Dodge:** 400, 600, Aries, Charger, Rampage, Daytona, Dynasty, Lancer, Maonaco, 024, Omni, Shadow, Spirit; **Eagle:** Medallion, Premier; **Ford:** Festiva, Aspire; **Isuzu:** I-Mark; **Plymouth:** Acclaim, Sundance, Caravelle, Horizon, Reliant, Scamp, TC3, Turismo; **Volkswagen:** Cabriolet, Quantum, Dasher, Fox, Golf, GTI, Jetta, Passat, Rabbit, Scirocco

SP75400 “GREY”

Acura: Integra; **Audi:** 100, 5000; **Buick:** Skyhawk, Skylark, Somerset; **Cadillac:** Cimarron; **Chevrolet:** Beretta, Cavalier, Citation, Corsica; **Chrysler:** Town & Country; **Dodge:** Caravan, Ram Van; **Ford:** Windstar; **Honda:** Civic, CRX, Prelude; **Mercury:** Village; **Nissan:** Quest; **Oldsmobile:** Achieva, Calais, Firenza, Omega; **Plymouth:** Voyager; **Pontiac:** Grand Am, Phoenix, J2000, Sunbird, Sunfire;

SP75800 “RED”

Buick: Century, Riviera; **Cadillac:** Eldorado, Seville; **Chevrolet:** Celebrity, Lumina Sedan, Nova, '95 Monte Carlo, '95 Lumina; **Geo:** Prizm; **Oldsmobile:** Aurora, Ciera, Cutlass, Cutlass Cruiser, Cutlass Supreme, Custom Cruiser FWD, Silhouette, Toronado, Trofeo; **Pontiac:** Grand Prix, Transport, 6000; **Toyota:** Camry, Corolla, Celica, Tercel;

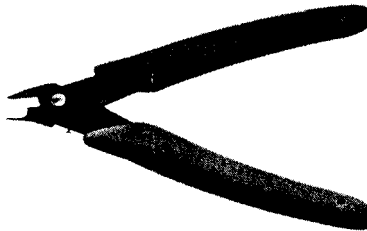

SP75915

“EZ SHIM” Cutter

This Cutter is a Necessary Tool for Proper Cutting of the “EZ SHIM”. It's Thin Cutting Blades Minimize Shim Breakage and Waste.



DEALER PRODUCTS, INC.

"KEX" TIRE REPAIR PRODUCTS

- > *Tie Gun Construction*
- > *Kex 3-Way Chemical Self-Vulcanizing Gun Base*
- > *3 Sizes to Choose From*
- > *Approved, Recommended, and Used by Manor Oil and Tire Companies.*

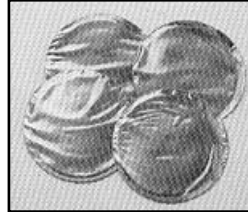

DPI Number	Part Description	Dimensions		Max. Injury		Qty Pkg
		Inches	MM	Inches	MM	
PE001	Small Round Patch	1-3/4	44	1/2	13	40
PE002	Medium Round Patch	2-1/4	57	1	25	30
PE003	Large Round Patch	3-1/8	79	2	51	20

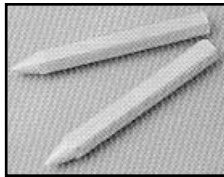

PE552

Kex Marking Crayon (Yellow);
1 per package



PE490NF

Rub-R-Flux Buffing Solution;
Non-Flammable;
1 Qt. Can;
12 per package



MT56122

Tubeless Tire Test Tank;
Find leaks in Tires and Tubes
quickly and easily;
Made of durable polyethylene to
withstand rugged use;
Length: 34"; Width: 14"; Dia: 12";
1 per package



MT45102

WHITE Tire Marking Crayon;
Makes a Bright Mark on Any Tire;
Doesn't Melt, Soften, or Rub off in the
Pocket. 3-7/8" X 1/2";
12 per box

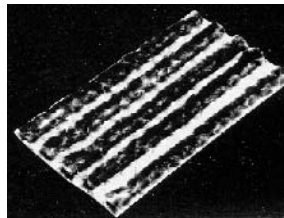

PE361

50 String Repairs "Fat";

PE371

100 String Repairs to be Used
with the PE360 Kit

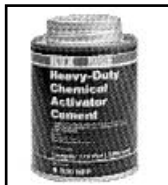

PE513NF

All Purpose Cement (Chemical
Activator);
1/2 Pint Can (.2366 Liter);
24 per package



DEALER PRODUCTS, INC.



CAMEL



TIRE CARE PRODUCTS & ACCESSORIES



AWCA12090

Bead Sealer;
Quart Can Brush-in Cap
Prevents Bead Leaks and
Eases Tire Installation;



AWCA15224

Radial Tire Tool;
Super-Grip Open Eye Needle;



AWCA12095

"STUF" Concentrated Tire
Mounting Lube;
8-lb. Pail Makes Five Gallons
when Mixed with Warm Water.
Stops Rubber Squeaks;
Easy to Use and Safe;



AWCA17295

Cotton Swab Applicator

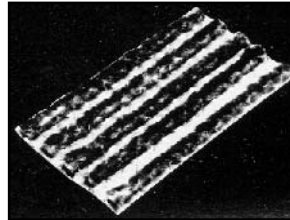

RADIAL INSERTS

(Repair Strings)

AWCA15206

7" (Black) Repair String; For Bias Ply
and Tubeless Tire Emergency Repairs;
50 per box

AWCA15280

Repairs for All Steel Belted Radials and
Other Tubeless Tires; Self-Vulcanizing;
60 per box

AWCA15281

Heavy Duty Radial Truck Repairs;
30 per box

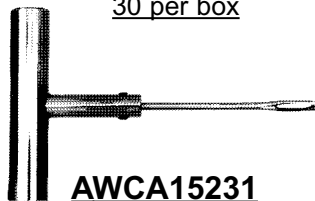

AWCA15231

Heavy Duty Truck Needle;
(Requires Handle #15230);



AWCA12086

Tire Repair - Universal
Cement;
1 per package (1/2 Pt Can)



AWCA15294

Medium Sidewall Plug-N-Patch;
For 1/8" Sidewall Puncture;
15 per package

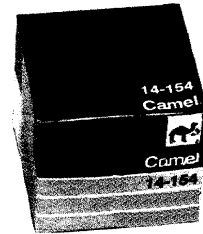

**Chembond Tube and
Bias Ply Patches**

Pure Rubber Flows into the
Injury. May be Applied with
Universal Cement or an
Electric Vulcanizer.

DPI Number	Type Patch
AWCA14152	Sml Rd.
AWCA14153	Med. Rd.
AWCA14154	Lrg. Rd.



AWCA15225

Radial Tire Tool;
Super-Grip Probe;

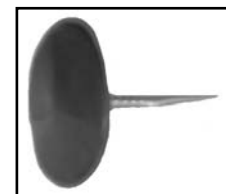

AWCA15293

Small Sidewall Plug-N-Patch;
For Pin-Hole Sidewall
Puncture;
20 per package

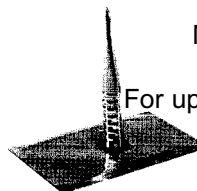

AWCA15291

Medium Reinforced
Plug-N-Patch;
For up to 1/8" Crown Puncture;
10 per package



DEALER PRODUCTS, INC.

“KEX” TIRE REPAIR PRODUCTS

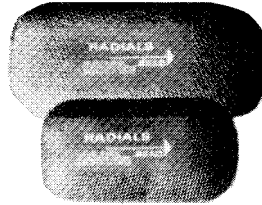

RADIAL PATCHES

“KX” Radial Patches

Reinforced to Handle the Flex in Radial Tires. Can Be Used for Either Passenger Radial Tire or Truck Radial Tire Applications. Unit Molded to Assure No Separation. Filling Insert Strips Provided with Each Box. Note: Conventional Patches Should Never Be Used on Radial Tires due to the Flex Characteristics of the Radial Tire.

DPI Number	Patch Description	Dimensions		Max. Injury	
		Inches	MM	Inches	MM
PE413	Small	1-3/4" X 3"	44 X 76	1/8"	3
PE414	Medium	2-1/4" X 4"	57 X 102	1/4"	6



DEALER PRODUCTS, INC.

"KEX" TIRE REPAIR PRODUCTS

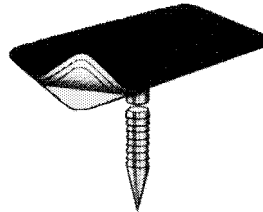

RADIAL TIRE PATCH-N-PLUG *With Metal Quill (Patent Pending)*

"KX" Radial Savers

The Original One-Piece, Unit Molded "Patch-n-Plug" Design. This is the Simplest, Most Convenient Way to Permanently Repair Steel Belted Radial Tires. The Metal Quill Protects the Plug from Damage by the Steel Wire During Installation and Simplifies Pulling it Through the Injury with Pliers. The Stem is Covered with Self-Vulcanizing Cushion Gum to Completely Vulcanize in the Injury to Seal Out Moisture and Eliminate Rust while the Patch Vulcanizes to the Inner-Liner to Permanently Seal the Air in the Tire. May be Used in Tread Shoulder and Sidewall Areas.

DPI Number	Patch Description	Dimensions	
		Inches	MM
PE375	Small Reinforced Stem Patch for up to 1/8" (3mm) Puncture	Stem: 1/4" Patch: 1-3/4" X 3"	6 33 X 76
PE381	Small Round Stem Patch for Pinhole Sidewall Puncture	Stem: 1/8" Patch: 2" X 2"	3 51 X 51
PE382	Medium Round Stem Patch for 1/8" Sidewall Puncture	Stem: 1/4" Patch: 2-3/4" X 2-3/4"	6 70 X 70



DEALER PRODUCTS, INC.

TOOLS AND GAUGES



SSA509

Professional Tire Gauge;
Calibrated from 5 to 50 Lbs. in 1 Lb. Units;
Brass Construction for Extra Strength;
Highly Polished Chrome;
Easy to Read 4-Sided Nylon Indicator Bar;
Handy Pocket Clip;
Individually Boxed;
10 per package

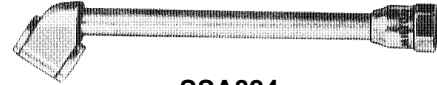

SSA824

Dual-Foot Extensions Chuck;
1/4" Female N.P.T. Closed Check Chuck;
10 per package



MT27117

3 Purpose Tool;
Can be Used For: Extension for
Mounting, Valve Core
Screwdriver, and Deflating Tubes;
1 per package

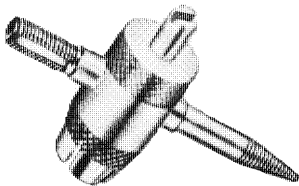

SSA600

4-Way Valve Repair Tool;
Repairs and Reconditions Inside and
Outside Valve Threads;
Inserts and Removes Cores;
Electro Plated, Rust Resistant;
10 per package



MT52385

Hubcap Puller and Replacer;
For Removing and Replacing
Hub Caps from all model cars
including Compact and Foreign.
Replaceable Rubber Head helps
Prevent Damage to the Hub Cap;
1 per package

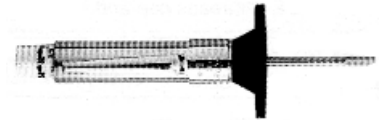

MT56454

Tread Depth Gauge;
Wide 1-1/4" base to span struck
treads; Calibrated in 1/32"; Blade
Probe also Measures Passenger
Tires;
1 per package



PE914BLK

Tire Patch Stitcher
1 per package



MT22634

Valve Puller;
Straight Tool Installs Any Length
Snap-In Valve in Any Width Rim;
1 per package

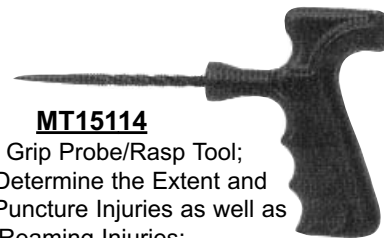

MT15114

Pistol Grip Probe/Rasp Tool;
Use to Determine the Extent and
Angle of Puncture Injuries as well as
Reaming Injuries;
1 per package



DEALER PRODUCTS, INC.

MISCELLANEOUS VALVES

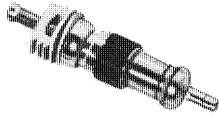

SSA151BK

Short Valve Stem Core;
Fits All Standard Tire Valves;
100 per package



SSA354BK

3/4" Valve Extension;
Solid Brass;
Nickle Plates;

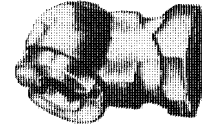

SSA815

Screw-On Ball-Foot Air Chuck;
1/4" Female Pipe Thread;
10 per package

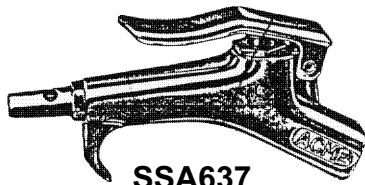

SSA637

Safety Blow Gun;
Meets OSHA Standards;
10 per package



MT22130

Chrome-Sleeve Snap-In Valves;
Schrader Equiv. 413SC;
Dill Equiv. T-13-S;
Length: 1-1/4";
Rim Hole: 453 Deg.



MT22529

Hex Head Chrome Cap;
Solid Hexagon Rod
Construction; Fits
Standard Chrome
Sleeve and Metal
Clamp-In Valves;



MT21532

Metal Dome Type Valve Cap;
Nickel Plated Brass Dome Top
Cap;
100 per box



MT24120

High Pressure Snap-In Valves;
Maximum Air Pressure: 100 PSI;
Fits Rim Hole .453"; Length: 1-
1/4";
1 per package

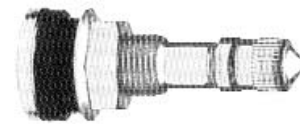

MT21583

TR-416 Clamp-In Tubless Metal
Valves; For Small or Large
Passenger Rim Holes;
Effective Length: 1-1/4";
1 per package



DEALER PRODUCTS, INC.

TUBELESS TIRE STEMS

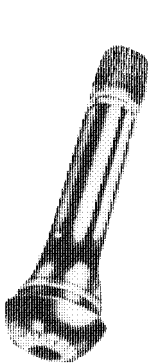

SSA258BK

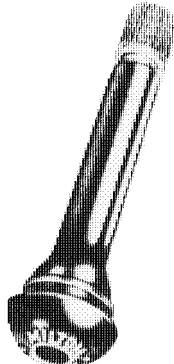

SSA259BK

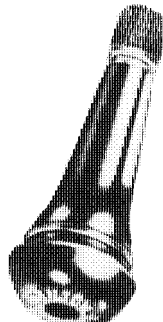

SSA254BK

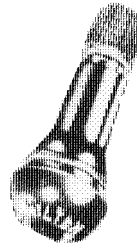

SSA256BK

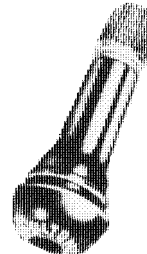

SSA257BK



SSA253BK

TUBELESS TIRE STEMS

Used for Both Original Equipment and Replacement Use. Snap-In Valves are Designed for Quick and Convenient Installation on Rims having .453 and .625 Diameter Valve Holes.

50 per package

<u>DPI Number</u>	<u>Tr. Number</u>	<u>Item Length</u>	<u>Rim Hole</u>
SSA253BK	415	1-1/4"	.625
SSA254BK	425	2"	.625
SSA256BK	413	1-1/4"	.453
SSA257BK	414	1-1/2"	.453
SSA258BK	418	2"	.453
SSA259BK	423	2-1/2"	.453

VALVE STEM CAPS AND EXTENSIONS



SSA359BK

2" Above Cap Extension;
50 per package



SSA358BK

1-1/4" Above Cap Extension;
50 per package

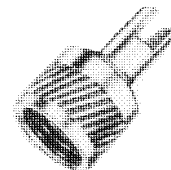

SSA301BK

Screw-Driver Type Cap;
100 per package



SSA357BK

3/4" Above Cap Extension;
50 per package

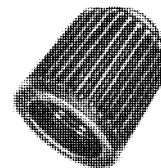

SSA310BK

Plastic Valve Cap;
100 per package