

HOSES & FITTINGS

SECTION "J"

DEALER PRODUCTS, INC
1185 108TH ST.
GRAND PRAIRIE, TX 75050
800-999-8828

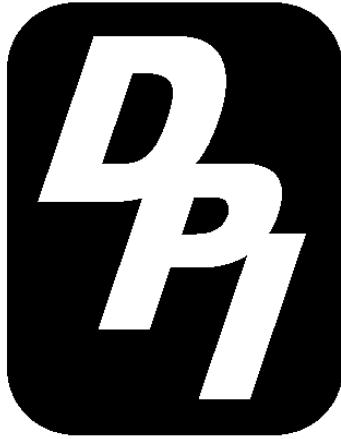



Section “J”

INDEX

DEALER PRODUCTS, INC
1185 108TH ST.
GRAND PRAIRIE, TX 75050
800-999-8828

“J” SECTION

INDEX

<u>Part Description</u>	<u>Page #</u>	<u>Part Description</u>	<u>Page #</u>
> Air Brake Fittings		> Hose Clamps	
Copper Tubing	J-059	A/C	J-010
	J-073-75	Mini	J-010
Gladhand Coupling	J-065	Stainless Steel	J-011
Hydraulic	J-061		
Nylon Tubing	J-062-64	> Hose Fittings	
Prestomatic	J-060	Clip/Spring	J-072
Special Purpose	J-061	Diesel	J-070-71
		Ends	J-072
> Air Couplers	J-001-07	Ferrules - Brass	J-074
		Low Pressure	J-067
> Brake Lines	J-025	Medium Pressure	J-069
		Miscellaneous	J-070
> Flush Tees	J-014		
		> Pipe Fittings	
> Grease Fittings	J-022-24	Black Iron	J-015-18
		Brass	J-042-52
			J-058
> Hoses		Drain & Shut Off	J-053-54
Air Brake	J-031	Low Pressure	J-055-56
Diesel	J-032	Steel	J-065-66
Freon	J-030	Welded Steel Nipples	J-019
Fuel	J-038		
Heater	J-037	> Quick Coupler Chart	J-009
Low Pressure	J-027-28		
Medium Pressure	J-029	> Tape/Sealants	J-013
Miscellaneous	J-035-36		
	J-038-39	> Tools	J-041
Nylon	J-034		
Power Steering	J-033		



DEALER PRODUCTS, INC.

ACME

AIR COUPLERS - 1/4" BASIC SIZE

700 SERIES

WARNING!!!
THE COUPLERS ON
THIS PAGE ARE
FOR USE WITH
SHOP AIR ONLY

ACME "KWIK-CHANGE" "T" Coupler

Designed to Interchange with Tru-Flate, Parker Hannifin Style Couplers
Sleeve Style - Brass Body - Steel Sleeve

1/4" Basic Size Hardened Steel Plugs. Rust Resistant, Maximum Air Flow for 1/4" Couplers.



SSA928N

1/4" N.P.T. Male
Coupler Plug



SSA929N

1/4" N.P.T. Female
Coupler Plug



SSA925B

1/4" N.P.T. Female
Coupler Body

ACME "KWIK-CHANGE" Lincoln Style Couplers

1/4" Basic Size; Push Type - Plug Engages Automatically; Steel Body - With
Hardened Steel Plugs, Rugged, Durable.



SSA933N

1/4" N.P.T. Male Plug



SSA934N

1/4" N.P.T. Female Plug

Quantities Are 10 Per Package



DEALER PRODUCTS, INC.

ACME

AIR COUPLERS - 1/4" BASIC SIZE

700 SERIES

WARNING!!!
THE COUPLERS ON
THIS PAGE ARE
FOR USE WITH
SHOP AIR ONLY

ACME "KWIK-CHANGE" "A" Coupler

Designed to Interchange with Aro Style Couplers
1/4" Basic Size; Push Type - Plug Engages Automatically;
All Steel Body With Hardened Steel Plugs; Rugged and Durable;

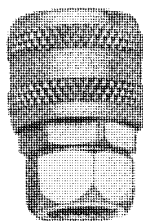

SSA918B

1/4" N.P.T. Female "A"
Coupler Body



SN914N

1/4" N.P.T. Male "A"
Coupler Plug

ACME "KWIK-CHANGE" Couplers

Used With All Air Operated Equipment Such As: Blow Guns, Tire Inflators, Paint
Sprayers, Air Hammers, Air Drills, Greasing Equipment, Oil Sprays.

- * Sleeve Style and Push Type
- * Brass Body - Brass Sleeve



SSA937B

1/4" N.P.T. Female
Coupler Body

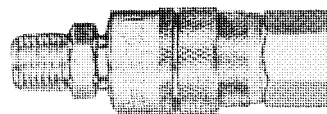

SSA939A

Kwik-Change Coupler Assembly
(# SSA937B Body and SSA910N
Plug - 1/4" N.P.T Female and
1/4" N.P.T. Male)

Quantities Are 10 Per Package



DEALER PRODUCTS, INC.

ACME

AIR COUPLERS - 1/4" BASIC SIZE

700 SERIES

WARNING!!!
THE COUPLERS ON
THIS PAGE ARE
FOR USE WITH
SHOP AIR ONLY

ACME "KWIK-CHANGE" Couplers

Used With All Air Operated Equipment Such as: Blow Guns, Tire Inflators, Paint Sprayers, Air Hammers, Air Drills, Greasing Equipment, and Oil Sprays.

- * Sleeve Style and Push Type
- * Brass Body - Brass Sleeve



SSA910N
1/4" N.P.T. Male
Coupler Plug



SSA911N
1/4" N.P.T. Female
Coupler Plug

MILTON AIR HOSE REPAIR PARTS

600 SERIES



SSA872
Hose Repair Splicer
For 3/8" ID Hose

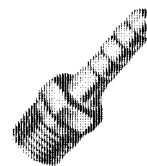

SSA850
1/4" Male N.P.T.
Use with 1/4" ID Hose



SSA870
Hose Repair Splicer
For 1/4" ID Hose

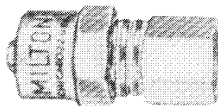

AW621
Re-Usable Hose End - Male
1/4" N.P.T. (Fits 3/8" ID
Hose X 3/4" OD Hose)

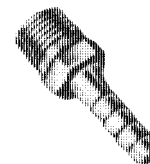

SSA852
1/4" N.P.T. Male
Use With 3/8" ID Hose

Quantities Are 10 Per Package



DEALER PRODUCTS, INC.

MILTON

AIR COUPLERS - 1/4" BASIC SIZE

700 SERIES

WARNING!!!
THE COUPLERS ON
THIS PAGE ARE
FOR USE WITH
SHOP AIR ONLY

MILTON "KWIK-CHANGE" Couplers

Used With All Air Operated Equipment Such as: Blow Guns, Tire Inflators, Paint Sprayers, Air Hammers, Air Drills, Greasing Equipment, and Oil Sprays.

- * Sleeve Style and Push Type
- * Brass Body - Brass Sleeve



AW711

Kwik-Change Coupler Assembly
(# SSA937B Body and SSA910N
Plug - 1/4" N.P.T. Female and
1/4" N.P.T. Male)



AW715

1/4" N.P.T. Female
Coupler Body



AW716

1/4" N.P.T. Male
Coupler Body



AW718

3/8" N.P.T. Female
Coupler Body



AW727

1/4" N.P.T. Male
Coupler Plug



AW728

1/4" N.P.T. Female
Coupler Plug

Quantities Are 10 Per Package



DEALER PRODUCTS, INC.

MILTON

AIR COUPLERS - 1/4" BASIC SIZE

700 SERIES

**WARNING!!!
THE COUPLERS ON
THIS PAGE ARE
FOR USE WITH
SHOP AIR ONLY**

MILTON "KWIK-CHANGE" "A" Coupler

Designed to Interchange With Aro Style Couplers
1/4" Basic Size; Push Type - Plug Engages Automatically;
All Steel Body with Hardened Steel Plugs. Rugged and Durable

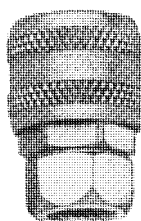

AW775
1/4" N.P.T. Female "A"
Coupler Body



AW777
1/4" N.P.T. Male "A"
Coupler Plug



AW778
1/4" N.P.T. Female "A"
Coupler Plug

MILTON "KWIK-CHANGE" "T" Coupler

Designed to Interchange With Tru-Flate, Parker Hannifin Style Couplers;

- * Sleeve Style
- * Brass Body - Brass Sleeve



AW783
1/4" N.P.T. Male
Coupler Plug



AW784
1/4" N.P.T. Female
Coupler Plug



AW785
1/4" N.P.T. Female
Coupler Body

Quantities Are 10 Per Package



DEALER PRODUCTS, INC.

MILTON

AIR COUPLERS - 1/4" BASIC SIZE

700 SERIES

WARNING!!!
THE COUPLERS ON
THIS PAGE ARE
FOR USE WITH
SHOP AIR ONLY

MILTON "KWIK-CHANGE" Lincoln Style Couplers

- * 1/4" Basic Size
- * Push Type - Plug Engages Automatically
- * Steel Body - With Hardened Steel Plugs; Rugged and Durable



AW790

1/4" N.P.T. Female Body



AW791

1/4" N.P.T. Male Plug



AW792

1/4" N.P.T. Female Plug

Quantities Are 10 Per Package



DEALER PRODUCTS, INC.



1/2" BASIC SIZE AIR COUPLERS

(For Push On and Lock Couplers & Fittings)

1800 SERIES

WARNING!!!
THE COUPLERS ON
THIS PAGE ARE
FOR USE WITH
SHOP AIR ONLY

1/2" Basic Size - Tru-Flate Style

These 1/2" Basic Size Bodies Work with Either Industrial Interchange or Tru-Flate Style Plugs.

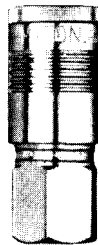

AW1815

Steel Body

1/2" N.P.T. Female Coupler Body

10 per package

1/2" Basic Size - Industrial Interchange

These 1/2" Basic Size Bodies Work with Either Industrial Interchange or Tru-Flate Style Plugs.



AW1857

Steel Body

1/2" N.P.T. Male Coupler Plug

10 per package



AW1858

Steel Body

1/2" N.P.T. Female Coupler Plug

10 per package



DEALER PRODUCTS, INC.

PUSH BUTTON COUPLINGS



IBC06

Replaces Milton # AW715;
"M" Style;
Accepts AW727 and
AW728 Nipples

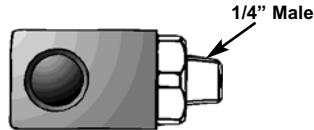

IBC07

Replaces Milton # AW716;
"M" Style;
Accepts AW727 and
AW728 Nipples



IBC08

Replaces Milton # AW775;
"A" Style;
Accepts AW777 and
AW778 Nipples

Non-Scratch, Push Button Coupling, Compressed Air Application. IBC Will Not Scratch Finished Surface; Light Weight, Fully Automatic, Leakage Free, Interchangeable
1 per package

DPI Number	IBC Description	Thread
IBC06	Sockets - Female	1/4" NPT
IBC07	Sockets - Male	1/4" NPT
IBC08	Sockets - Female	1/8" NPT



DEALER PRODUCTS, INC.

QUICK COUPLER INTERCHANGE CHART

Acme Quick Couplers Make For Fast, Effortless Coupling and Uncoupling of Air Tools and Equipment. "Push-Pull" Action is Instantaneous and Air Tight. Coupler Bodies Feature Built-In Automatic Air Shut-Off Valves that Instantly Seal the Lines When Nipples are Disconnected. Coupler Design Prevents Hose Kinks.

Acme	American Parts	Amflo	Aro	Bridgeport Camel	Balkamp	Diamond U	Dill	Lincoln	Milton	Shrader	Tru-Flate
A910A	9-706	CP21	23902-210	578	4-6610	16P21	10010	630104	727	5138-11	12-224 12-225
A911N	9-708	CP20	23902-200	579	4-6611	16P20	10009	630204	728	5139-11	12-234 12-235
A914N	9-683	CP37	2608	528	4-821	1210MP	8891	13329	777	3529	12-324 12-325
A916N	9-685	CP38	2609	529	4-822	1210FP	8889	13331	778	3530	12-334 12-335
A918B	9-690	C38	210	526	4-821	1210	8888	862	775	3526	13-334 12-335
A925B	9-663 9-677	C2		223 523	4-675	15C2	D-13		785	3504	13-104 13-134
A926B	9-664 9-676	C1		524	4-674	15C1	D-12		786	3503	13-102 13-124
A928N	9-666 9-668	CP1		238 538	4-685	15P1	D-2C		783	3506	12-122 12-124
A929N	9-667 9-669	CP2		239 539	4-686	15P2	D-3C		784	3507	12-132 12-134
A933N	9-696	CP27		550	4-693	19MP	10026	11659	791	3531	12-424 12-425
A934N	9-698	CP28		551	4-695	19FP	10025	11661	792	3532	12-434 12-435
A935B	9-694	C28		548	4-683	19FB	10023	815	790	3528	13-434 13-435
A937B	9-703 9-712	C20	23102-200	573	573	16C20	1002	612004 632004	715	5138-12 5141-12	13-254 13-234
A938B	9-701 9-711	C21	23102-012	574	574	16C21	1003	611004 631004	716	5139-12 5141-12	13-244 13-224
A939A				572					711	5142C-D	13-201
A940B	9-679	C6		553	4-677	15C6	D-15		1805	3516	13-612 13-613
A940N	9-674	CP5		558	4-687	15P5	D-2E		1807	3517	12-604 12-605
A941N	9-675	CP6		559	4-688	15P6	D-3E		1808	3518	12-612
A944B		C8		476		16C6-22	D-15C		1803	3521	13-610 13-611
A944N		CP7		480		15P502	D-0E		1809	3519	12-602 12-603
A945N		CP8		481		15P6-22	D-1E		1810	3520	12-610
A942B	9-681	C10	23104-400	563	4-679	15C10	D-17	652008	1815	3512	13-712 13-713
A942N	9-672	C9		568	4-689	15P9	D-2F		1817	3513	12-704 12-705



DEALER PRODUCTS, INC.

HOSE CLAMPS

MINI CLAMP SERIES



DPI Number	Minimum Diameter	Maximum Diameter	Hose ID Size	Box Qty.
TD6202 #4	7/32"	5/8"	3/16" TO 5/16"	10
TD6203 #6	5/16"	7/8"	1/4" TO 3/8"	10
TD6204 #12	9/16"	1-1/4"	5/8" TO 3/4"	10

AIR CONDITIONING CLAMPS

WITH LOCATOR BAR FOR CORRECT POSITIONING

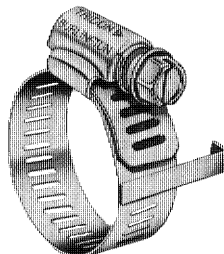

DPI Number	Minimum Diameter	Maximum Diameter	Normal Diameter	Fits AC Hose Size	Box Qty.
TD185008	7/16"	1"	9/16"	6-8	10
TD185010	9/16"	1-1/8"	5/8"	10	10



DEALER PRODUCTS, INC.

HOSE CLAMPS

STAINLESS STEEL BANDS

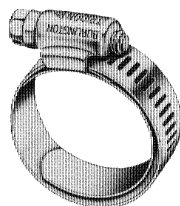

DPI Number	Minimum Diameter	Maximum Diameter	Hose Size	Box Quantity
TD5006	3/8"	25/32"	1/4" to 3/8"	10
TD5008	3/8"	29/32"	5/16" to 1/2"	10
TD5010	1/2"	1-1/16"	3/8" to 5/8"	10
TD5012	1/2"	1-1/4"	5/8" to 3/4"	10
TD5016	7/8"	1-1/2"	3/4" to 1-1/2"	10
TD5020	1-3/16"	1-3/4"	1" to 1-1/4"	10
TD5024	1-1/16"	2"	1-1/4" to 1-1/2"	10
TD5028	1-5/16"	2-1/4"	1-1/4" to 1-3/4"	10
TD5032	1-9/16"	2-1/2"	1-1/2" to 2"	10
TD5036	1-13/16"	2-3/4"	1-3/4" to 2-1/4"	10
TD5040	2-1/16"	3"	2" to 2-1/2"	10
TD5044	2-5/16"	3-1/4"	2-1/4" to 2-3/4"	10
TD5048	2-9/16"	3-1/2"	2-1/2" to 3"	10
TD5052	2"	3-3/4"	1-7/8" to 3-3/4"	10
TD5056	1"	4"	1" to 3-1/2"	10
TD5064	1-1/2"	4-1/2"	1-1/2" to 4"	10
TD5072	3-1/4"	5"	3-1/8" to 5"	10
TD50104	2"	7"	2" to 6-1/2"	10

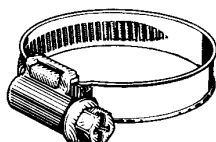

European Style Hose Clamps

Unique off-set non-welded design of the housing saddle gives a smooth underside ensuring high sealing efficiency. These clamps are original equipment on both domestic and import vehicles. They are particularly suited for fuel, vacuum, water, emission, and heater hoses and can be used with silicone hoses.

DPI Number	Clamping Range	Hex Size	Band Width	Qty Pkg.
AV16868	8mm-12mm (5/16"-1/2")	5mm	8mm (5/16")	10
AV16869	10mm-16mm (3/8"-5/8")	5mm	8mm (5/16")	10
AV16871	8mm-16mm (5/16"-5/8")	6mm	9mm (11/32")	10
AV16872	12mm-20mm (1/2"-3/4")	6mm	9mm (11/32")	10
AV16873	16mm-25mm (5/8"-1")	6mm	9mm (11/32")	10
AV16874	20mm-32mm (3/4"-1-1/4")	6mm	9mm (11/32")	10
AV16875	25mm-40mm (1"-1-5/8")	6mm	9mm (11/32")	10
AV16877	32mm-50mm (1-1/4"-2")	6mm	9mm (11/32")	10
AV16878	40mm-60mm (1-5/8"-2-3/8")	6mm	9mm (11/32")	10



DEALER PRODUCTS, INC.

HOSE CLAMPS

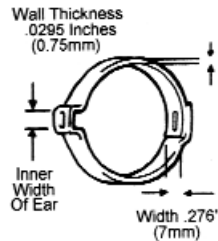

Crimp Type Hose Clamps - Zinc Plated

For Low Pressure Applications such as Automotive, Appliance, Industry Machinery, etc.

Part Number	Nominal Size	Inches		mm		Inner Width of Ear		Qty. Pkg.
		Closed	Open	Closed	Open	Inches	mm	
AV18436	3/8"	.350	.414	8.9	10.5	.197	5	25
AV18437	7/16"	.381	.444	9.7	11.3	.197	5	25
AV18438	15/32"	.394	.486	10.4	12.3	.197	6	25
AV18439	1/2"	.453	.524	11.4	13.3	.236	6	25
AV18440	35/64"	.472	.551	11.9	14.0	.256	6.5	25
AV18441	9/16"	.496	.571	12.6	14.5	.236	6	25
AV18442	5/8"	.543	.618	13.8	15.7	.236	6	25
AV18443	11/16"	.594	.669	15.1	17.0	.236	6	25
AV18444	23/32"	.618	.728	15.7	18.5	.354	9	25
AV18445	3/4"	.669	.779	17.0	19.8	.354	9	25
AV18446	7/8"	.779	.890	19.8	22.6	.354	9	25
AV18447	1"	.898	1.008	22.8	25.6	.354	9	25

NYLON HOSE CLAMPS

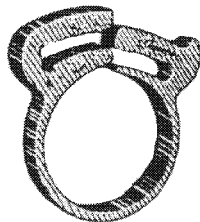

DPI Number	Clamp Size
CK468	#6 (17/32")
CK593	#10 (21/32")
CK16870C	1-11/16 (1-29/32")



DEALER PRODUCTS, INC.

DPI TEFLON* THREAD SEAL TAPE



DPI Teflon Tape is Made of Durable Virgin Teflon and can be Wound Around Threads of Any Metal, Plastic, or Rubber Pipes to Provide Leak-Free Joints That Will Never Freeze or Harden with Age.

It is UL-Approved, Recognized by the National Sanitation Foundation for Water Systems Applications, and Designed to Meet MIL-T-27730A Specifications.

* DUPONT T.M.

DPI Number	Tape Width	Tape Length
MI250	1/2"	260"
MI251	3/4"	260"
MI252	1"	260"



LOCTITE PST PIPE SEALANT WITH TEFLON

Locks and Seals Threaded Fittings. Resists Leakage, Vibration Loosening, Moisture, Hydraulic Fluids and Diesel Fuels. Lubricates Thread for Easy Assembly and Disassembly. Won't Shred or Wear Like Teflon Tape. Repositionable up to 24 Hours.

DPI Number	Tube Size	Qty. Pkg
LC59214	6 mL Tube	12
LC59231	50 mL Tube	6



DEALER PRODUCTS, INC.

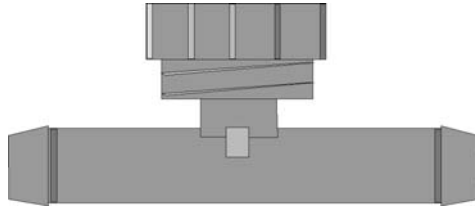

PLASTIC FLUSH TEES

DPI Number	Tee Size	Tee Type
RB54150	1/2"	Flush Tee
RB54162	5/8"	Flush Tee
RB54175	3/4"	Flush Tee



DEALER PRODUCTS, INC.

STANDARD MALLABLE BLACK IRON PIPE FITTINGS



BUSHING					
DPI Number	Size	Qty. Pkg.	DPI Number	Size	Qty. Pkg.
WA4096	1/4" X 1/8"	10	WA41003	1" X 3/8"	5
WA2388	3/8" X 1/8"	10	WA4101	1" X 1/2"	5
WA4097	3/8" X 1/4"	10	WA4102	1" X 3/4"	5
WA4098	1/2" X 1/4"	5	WA4374	1-1/4" X 1"	5
WA4099	1/2" X 3/8"	5	WA4375	1-1/2" X 3/4"	2
WA40991	3/4" X 1/8"	5	WA4106	1-1/2" X 1-1/4"	2
WA2406	3/4" X 1/4"	5	WA4302	2" X 1-1/4"	2
WA2387	3/4" X 3/8"	5	LN13365	2" X 1"	2
WA4100	3/4" X 1/2"	5	WA4108	2" X 1-1/2"	2



SOCKET HEAD FLUSH PLUGS

DPI Number	Plug Size
BP18	1/8"
BP14	1/4"
BP38	3/8"
BP12	1/2"
BP34	3/4"
BP1	1"
BP114	1-1/4"
BP112	1-1/2"
BP2	2"



WA90601

Metric Hex Head Plug
For GM Manifold Port
18mm X 1.5mm



DEALER PRODUCTS, INC.

STANDARD MALLABLE BLACK IRON PIPE FITTINGS



REDUCE COUPLING

DPI Number	Size	Qty Pkg
WA4109	1/4" X 1/8"	10
WA4110	3/8" X 1/4"	10
WA4111	1/2" X 1/4"	5
WA4112	1/2" X 3/8"	5
WA4113	3/4" X 1/4"	5
WA4114	3/4" X 1/2"	5
WA41141	1" X 3/8"	5
WA4116	1" X 3/4"	5
WA4390	1-1/4" X 3/4"	5
WA4303	1-1/4" X 1"	5
WA4304	1-1/2" X 1-1/4"	5

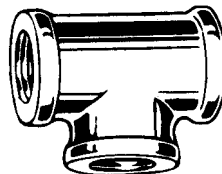

TEES - FEMALE

DPI Number	Pipe Size	Unit Pack
WA4002	1/8"	5
WA4006	1/4"	5
WA4011	3/8"	5
WA4021	1/2"	5
WA4037	3/4"	5
WA4052	1"	5
WA4073	1-1/2"	5



CLOSE NIPPLE

DPI Number	Pipe Size	Unit Pack
WA3001	1/8"	10
WA3008	1/4"	10
WA3014	3/8"	10
WA3020	1/2"	10
WA3051	3/4"	10
WA3052	1"	5
WA3056	1-1/4"	5
WA3057	1-1/2"	5



DEALER PRODUCTS, INC.

STANDARD MALLABLE BLACK IRON PIPE FITTINGS



MERCHANT COUPLING

DPI Number	Pipe Size	Unit Pack
WA4120	1/8"	10
WA4009	1/4"	10
WA4014	3/8"	10
WA4027	1/2"	5
WA4043	3/4"	5
WA4058	1"	5
WA4066	1-1/4"	5
WA4077	1-1/2"	5
WA4084	2"	5

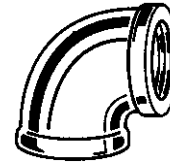

90 DEGREE FEMALE ELBOW

DPI Number	Pipe Size	Unit Pack
WA4001	1/8"	5
WA4005	1/4"	5
WA4010	3/8"	5
WA4017	1/2"	5
WA4033	3/4"	5
WA4048	1"	5
WA4062	1-1/4"	5
WA4071	1-1/2"	5

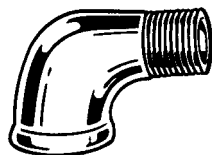

90 DEGREE STREET ELBOW

DPI Number	Pipe Size	Unit Pack
WA4350	1/8"	5
WA4351	1/4"	5
WA4385	3/8"	5
WA4015	1/2"	5
WA4031	3/4"	5
WA4047	1"	5
WA4352	1-1/4"	5

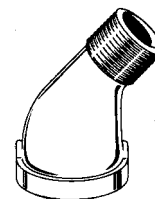

45 DEGREE STREET ELBOW

DPI Number	Pipe Size	Unit Pack
WA40151	1/8"	5
WA40152	1/4"	5
WA40153	3/8"	5
WA4016	1/2"	5
WA4032	3/4"	5



DEALER PRODUCTS, INC.

STANDARD MALLABLE BLACK IRON PIPE FITTINGS

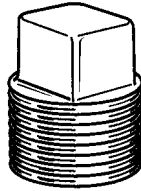

SOLID PLUGS

DPI Number	Pipe Size	Unit Pack
WA4003	1/8"	10
WA4007	1/4"	10
WA4012	3/8"	10
WA4022	1/2"	10
WA4038	3/4"	10
WA4053	1"	15
WA4064	1-1/4"	25
WA4074	1-1/2"	25
WA4082	2"	5

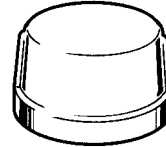

CAPS

DPI Number	Pipe Size	Unit Pack
WA4004	1/8"	10
WA4008	1/4"	10
WA4013	3/8"	10
WA4023	1/2"	10
WA4039	3/4"	10
WA4054	1"	5
WA4025	1-1/2"	5
WA4083	2"	5

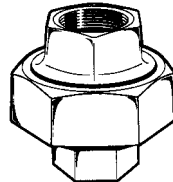

150 LB. GROUND

DPI Number	Pipe Size	Unit Pack
WA4363	1/8"	5



DEALER PRODUCTS, INC.

WELDED STEEL NIPPLES

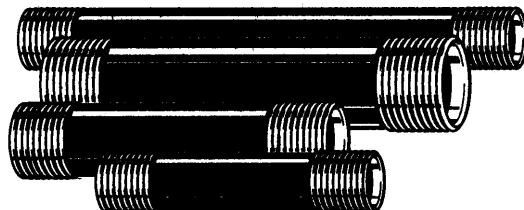

1/8" DIAMETER

DPI Number	Length	Unit Pack
WA3002	1-1/2"	5
WA3003	2"	5
WA3004	3"	5
WA3006	3-1/2"	5
WA3007	4"	5

1/4" DIAMETER

DPI Number	Length	Unit Pack
WA3013	1-1/2"	5
WA3009	2"	5
WA3010	3"	5
WA3018	4"	5
WA3019	5"	5
WA3021	6"	5

3/8" DIAMETER

DPI Number	Length	Unit Pack
WA3023	1-1/2"	5
WA3015	2"	5
WA3027	3"	5
WA3028	4"	5
WA3029	5"	5

1/2" DIAMETER

DPI Number	Length	Unit Pack
WA3022	2"	5
WA3024	3"	5
WA3025	4"	5
WA3032	5"	5

5/8" DIAMETER

DPI Number	Length	Unit Pack
WA3053	2"	5
WA3055	3"	5
WA3034	4"	5

1" DIAMETER

DPI Number	Length	Unit Pack
WA3037	2"	5
WA3038	3"	5
WA3040	4"	5
WA3041	5"	5







DEALER PRODUCTS, INC.

HYDRAULIC GREASE FITTINGS

Male Pipe Thread Fittings



CN610
1/8" Pipe Thread;
11/16" Length;
Straight; Ball Check



CN667
1/8" Pipe Thread;
1-1/4" Length;
Straight; Ball Check



CN611
1/8" Pipe Thread;
11/16" Length;
38° Elbow; Ball Check

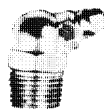

CN612
1/8" Pipe Thread;
27/32" Length;
67° Elbow; Ball Check

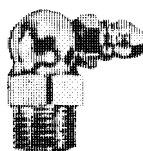

CN613
1/8" Pipe Thread;
13/16" Length;
90° Elbow; Ball Check

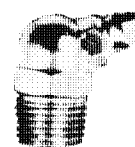

LN7587
1/4" NPT
65° Elbow
Ball Check



CN627
1/4" Pipe Thread
59/64" Length
Straight; Ball Check



CN688
1/8" Pipe Thread;
1" Length;
45° Elbow; Ball Check



DEALER PRODUCTS, INC.

HYDRAULIC GREASE FITTINGS

1/4" - 28 Thread Fittings



CN641

1/4" - 28 Thread;
17/32" Length;
Straight; Ball Check



CN652

1/4"-28 Thread;
45/64" Length;
Straight; Ball Check



CN680

1/4"-28 Thread;
15/16" Length;
Straight; Ball Check



CN698

1/4" - 28 Thread;
11/16" Length;
Straight; Ball Check



CN637

1/4"-28 Thread;
7/8" Length;
45° Elbow; Ball Check



CN636

1/4"-28 Thread;
1" Length;
45° Elbow; Ball Check



CN638

1/4" - 28 Thread;
47/64" Length;
Straight; Ball Check



CN2641

1/4"-28 Thread;
Self-Tapping;
Straight; Ball Check



CN792

1/4"-28 Thread (Short);
Self-Tapping
Straight



CN2637

1/4" - 28 Thread;
7/8" Length;
45° Elbow; Ball Check;
Self-Tapping



CN2638

1/4"-28 Thread;
47/64" Length;
90° Elbow; Ball Check
Self-Tapping



DEALER PRODUCTS, INC.

HYDRAULIC GREASE FITTINGS

Drive Type Fittings



CN608
5/16" Drive Size;
Straight
Ball Check



CN728
3/16" Drive Size;
Straight
Ball Check



CN743
39/64" Length;
1/4" Drive Size;
Straight; Ball Check

Metric Thread Fittings



CN3641
6mm X 1.0mm
Straight
CN10641
10mm X 1.0mm
Straight



CN3638
6mm X 1.0mm
90° Angle
CN10911
10mm X 1.0mm
90° Angle



CN3637
6mm X 1.0mm
45° Angle
CN10637
10mm X 1.0mm
45° Angle



CN3610
8mm X 1.0mm
Straight



CN3613
8mm X 1.0mm
90° Angle



CN3688
8mm X 1.0mm
45° Angle



DEALER PRODUCTS, INC.

WEATHERHEAD STEEL HYDRAULIC BRAKE LINES



- > Fusionweld Tubes.
- > Standard Equipment for Every Car and Truck with Hydraulic Brakes.
- > Solid Walls with Outer Surface Tin Coated to Prevent Rust and Corrosion.
- > Tubes are Flared with a Strong Eduring Double Lap Flare on Both Ends.
- > Assembled Complete with 1/4" Inverted Flare Steel Nut on Each End

DPI Number	Line O.D.	Line Length
WHS308	3/16"	8"
WHS312	3/16"	12"
WHS320	3/16"	20"
WHS330	3/16"	30"
WHS340	3/16"	40"
WHS351	3/16"	51"
WHS360	3/16"	60"
WHS412	1/4"	12"
WHS420	1/4"	20"
WHS430	1/4"	30"
WHS440	1/4"	40"
WHS451	1/4"	51"
WHS460	1/4"	60"
WHS512	5/16"	12"
WHS520	5/16"	20"
WHS530	5/16"	30"
WHS540	5/16"	40"
WHS551	5/16"	51"
WHS560	5/16"	60"
WHS612	3/8"	12"
WHS620	3/8"	20"
WHS630	3/8"	30"
WHS640	3/8"	40"
WHS651	3/8"	51"
WHS660	3/8"	60"



DEALER PRODUCTS, INC.

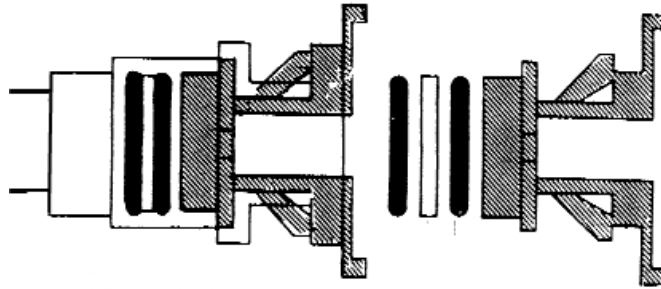

CP957456

Coupler Kit;
3/4" Heater Hose;
Contains 1 Retainer, 1 Mid
Spacer, 2 O-Rings;
Ford Light Duty Trucks '86/.
Replaces E69Z-18D434-A
5 per package

CP957457

Coupler Kit;
5/8" Heater Hose;
Contains 1 Retainer, 1 Mid
Spacer, 2 O-Rings;
Ford Light Duty Trucks '86/.
Replaces E69Z-18D434-B
5 per package



DEALER PRODUCTS, INC.

STRATOFLEX LOW PRESSURE - STRATOGRIP HOSE

GROUP XI



203 HOSE

Hose Construction: A Seamless Rubber Inner Tube, Reinforced with One Layer of Fabric, and Covered with a Synthetic Rubber Cover.

Identification: Hose is Identified by Part Number and Size.

Uses: Suitable for Automotive and Industrial Lines Carrying Water, Oil, Crude and Fuel Oils, Gasoline, Diesel Fuel, Anti-Freeze Solutions, Vacuum Gauge and Air Applications.

Temperatures: Liquids: -40° F through +200° F; Air: -40° F through +160° F.

DPI Number	Hose Size	Hose I.D.	Hose O.D.	Min Burst Pressure	Max Working Pressure	Min Bend Radius
SF2034	-4	1/4"	.48"	1000 PSI	250 PSI	3.00
SF2036	-6	3/8"	.61"	1000 PSI	250 PSI	3.00
SF2038	-8	1/2"	.75"	1000 PSI	250 PSI	5.00



223 HOSE

Hose Construction: A Seamless Rubber Inner Tube, Reinforced with One Layer of Fabric, and Covered with a Synthetic Rubber Cover; Impregnated, Oil Resistant Fiber Braid.

Identification: Hose is Identified by Part Number and Size.

Uses: Suitable for Automotive and Industrial Lines Carrying Water, Oil, Crude and Fuel Oils, Gasoline, Diesel Fuel, Anti-Freeze Solutions, Vacuum Gauge and Air Applications.

Temperatures: Liquids: -40° F through +200° F; Air: -40° F through +160° F.

DPI Number	Hose Size	Hose I.D.	Hose O.D.	Min Burst Pressure	Max Working Pressure	Min Bend Radius
SF2236	-6	3/8"	.61"	1000 PSI	250 PSI	3.00



DEALER PRODUCTS, INC.



**LOW PRESSURE HOSE
H009 (SAE 100R6)**

Commercial Version MIL-H-13444 Type I

Use 009 Series Hose Ends

Inner Tube: Buna-N

Reinforcement: 1 Fiber Braid

Cover: Neoprene

DPI Number	Hose I.D.	Hose O.D.	Rec Oper Pressure	Min Burst Pressure	Max Bend Radis
WHH0090550R	.3125"	.5625"	400 PSI	1600 PSI	3.00
WHH0090650R	.375"	.625"	400 PSI	1600 PSI	3.00



DEALER PRODUCTS, INC.

STRATOFLEX MEDIUM PRESSURE HOSE *GROUP I*



211 HOSE

Hose Construction: A Seamless Rubber Inner Tube, Reinforced with One Fiber Braid, and One Braid of High Tensile Steel Wire, and Covered with a Synthetic Rubber Impregnated, Oil Resistant Fiber Braid.

Identification: Hose is Identified by Part Number and Size.

Uses: Stratoflex 211, Single Wire Braid Hose, is an All-Purpose Hose Suitable for Universal Industrial Applications. It is Recommended for Hydraulic, Air, Water, Fuels, Hot Oil, Gasoline, Anti-Freeze and Many Other Fluids and Gases

Temperatures: -40° F through +250° F

DPI Number	Hose Size	Hose I.D.	Hose O.D.	Min Burst Pressure	Max Working Pressure	Min Bend Radius
SF2114	-4	3/16"	.52"	12000 PSI	3000 PSI	3.00
SF2116	-6	5/16"	.67"	9000 PSI	2500 PSI	4.00
SF2118	-8	13/32"	.77"	8000 PSI	2000 PSI	4.63



DEALER PRODUCTS, INC.

STRATOFLEX FREON HOSE

GROUP XV



255 HOSE

Hose Construction: A Seamless Rubber Inner Tube, Reinforced with Two Fabric Braids and Covered with a Weather, Oil, and Abrasion Resistant Synthetic Rubber Cover, Which is Perforated to Resist Blisters.

Uses: Specifically Designed for Automotive and Commercial Lines Carryig Freon 12.

Temperatures: -20° F through +250° F

DPI Number	Hose Size	Hose I.D.	Hose O.D.	Min Burst Pressure	Max Working Pressure	Min Bend Radis
SF2556	6	5/16"	.795"	1750 PSI	400 PSI	4.00
SF2558	8	13/32"	.91"	1750 PSI	400 PSI	5.00
SF25510	10	1/2"	1.00"	1750 PSI	400 PSI	6.00
SF25512	12	5/8"	1.13"	1750 PSI	400 PSI	6.00



DEALER PRODUCTS, INC.



PD10375

Rubber Brake Hose

Size: 3/8"

Comes in Bulk of 250 feet.

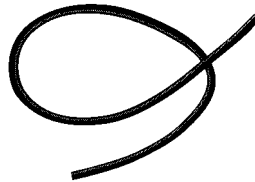

PHNB25025

Nylon Flexible Tubing;

Flexible Nylon Tubing is Carefully Made from High-Grade,
Abrasion-Resistant, Heat-and-Light Stabilized Nylon 11.
Resistance to Stress-Cracking Greatly Exceeds That of Ordinary
Nylon Tubing. Extremely Low Level of Water Absorption.

Nominal Tube O.D.	Nominal Tube I.D.	Ave. Wall Thickness	Working Pres. At 72F PSI
5/32"	106	.025	300



DEALER PRODUCTS, INC.

STRATOFLEX DIESEL HOSE

GROUP XIII



213 HOSE

Specifications: Department of Transportation FMVSS 106-74, Type A1; SAE J1402, Table A1 (Previous Type E); And the Maintenance Council of ATA (RCCC) RP307.

Hose Construction: Seamless HSP Elastomeric Inner Tube, Rein Forced with a Fiber Braid, A High Tensile Steel (Corrosion Protected) Wire Braid Encased in Rubber, and Covered with a Black Synthetic Rubber Impregnated Oil and Abrasion Resistant Polyester Braid.

Identification: Two Green Stripes 180° Apart, Part Number, Stratoflex, and Appropriate Dot and SAE Markings.

Application: Medium Pressure Service with Diesel Engine and Transmission Fuels, Oils, Coolants, Air Brake Systems, and Approved Hydraulic Applications; And Air Compressor Non-Detergent Petroleum Based Oils or Synthetic Diester Based Lubricants.

Temperatures: -50° F (-45° C) to +300° F (+150° C) with Petroleum Based Oils, Air or Aerated Oil. -50° F (-45° C) to +250° F (+120° C) with Water Glycol Solutions, or Diester Based Lubricants.

DPI Number	Hose Size	Hose I.D.	Hose O.D.	Min Burst Pressure	Max Working Pressure	Min Bend Radius
SF2134	-4	3/16"	.49"	6000 PSI	1500 PSI	.75
SF2136	-6	5/16"	.62"	6000 PSI	1500 PSI	1.25
SF2138	-8	13/32"	.74"	5000 PSI	1250 PSI	1.75
SF21310	-10	1/2"	.83"	4000 PSI	1000 PSI	2.25
SF21312	-12	5/8"	.96"	3000 PSI	750 PSI	2.75
SF21316	-16	7/8"	1.21"	1600 PSI	400 PSI	3.50
SF21320	-20	1-1/8"	1.49"	1250 PSI	300 PSI	4.50



DEALER PRODUCTS, INC.

POWER STEERING HOSE

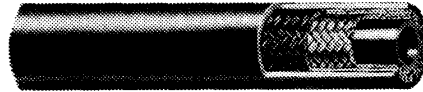

H324 SAE J188 TYPE II

Use Hose End Fittings for Rubber Hose

Inner Tube: Neoprene

Reinforcement: 2 Fiber Braids

Cover: Neoprene

Uses: for Power Steering Hose Applications

Cubic Expansion: 9 to 15 CC/FT. @ 1300 PSI

Temperatures: -40° F through +250° F (-40°C to +121° C)

DPI Number	Hose I.D.	Hose O.D.	Recommended Operating Pressure	Min Burst Pressure	Min Bend Radius
WHH32406	3/8"	3/4"	1400 PSI	5600 PSI	3-1/8"



DEALER PRODUCTS, INC.

NYLON TUBING

NT100 "NYLON" 11

Developed Specifically for Air Brake Applications. Can also be used in a Wide Range of Instrumentation and Secondary Air Systems. Meets all Requirements of SAE J844, Type A & B and FMVSS 571.106. Offers Good Resistance to Butane, Coal, Gas, Gasoline, Kerosene, Methane, Oxytgen, Propane, Turpentine.

CAUTION: Tubing is Attached by Battery Acid!

Type A Available in 1/8" and 1/4" Sizes Only; Reinforced.

Type B Available in 3/8" and Larger Sizes Only; Reinforced.

Temperature Range: -40° F to 200° F.

Construction: Core - Nylon; Braid - Polyamide Fiber; Jacket - Nylon; Contains Ultra-Violet Stabilize.



JAE J844; Type A;
Single Wall; Extruded Nylon;
Size: 1/8" and 1/4"



SAE J844; Type B;
Extruded Nylon Inner Tube;
Reinforcement: One Layer of Open Ply
Nylon Fiber;
Cover: Nylon;
Size: 3/8" through 3/4"

DPI Number	Dimen O.D.	Dimen Wall	Max Wk Press PSI @ 70F	Min Burst Press PSI @ 70F	Min Bend Radius PSI @ 70F	Coil Length Feet
WHNT10002BK	1/8"	.023"	150	1000	.375"	100
WHNT10004BK	1/4"	.040"	150	1200	1.0"	100
WHNT10006BK	3/8"	.062"	150	1400	1.5"	100
WHNT10008BK	1/2"	.062"	150	950	2.0"	100
WHNT10012BK	3/4"	.092"	150	800	3.0"	100



DEALER PRODUCTS, INC.



HOSE and TUBING

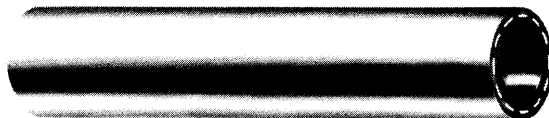

CRANKCASE VENTILATION HOSE

Crankcase Ventilation Hose Meets or Exceeds SAE 306R Requirements. Special Nitrile Tube Resists Deterioration from Gasoline, Carbon Monoxide, Exhaust Fumes, and Engine Heat. Special Neoprene Cover for Maximum Oil Resistance and Extended Life.

DPI Number	Hose Desc	Hose Length	Case Qty
CR1132	11/32" X 1" Knit	25'	1
CR1532	15/32" X 1" Knit	25'	1

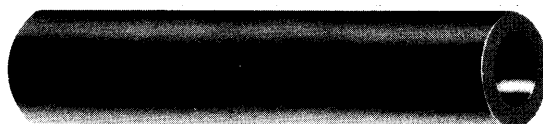

RADIATOR OVERFLOW TUBING

Compounded to Resist Oil, Gasoline, and Radiator Additives. Remains Flexible in Cold Temperatures. Manufactured to Meet SAE J200 BA 715.

DPI Number	Hose Size	Hose Length	Case Qty
CR62150	5/16"	50'	1



DEALER PRODUCTS, INC.



HOSE and TUBING



ALL PURPOSE SERVICE STATION AIR HOSE

This Multi-Purpose Rubber Air Hose Gives Excellent Service for All Types of Commercial Air Application. Cover Provides Maximum Resistance to Abrasion, Weather, and Ozone Deterioration. Remains Flexible in Extreme Cold. Tube Designed to Handle Oil Laden Air and Other Application where Medium Oil Resistance Tube is Required. Also Suitable for Agricultural Spray Applications Including Monsanto's "Lasso". High Tensile Reinforcing for Extended Life at Maximum Working ressure. Male Fittings at Both Ends

DPI Number	Hose Desc.	Fitting Size	Hose Length	Case Qty.
250 LBS Working Pressure				
CR42225	1/4" I.D. X 5/8" O.D.	1/4" NPT	25'	10
CR42250	1/4" I.D. X 5/8" O.D.	1/4" NPT	50'	5
200 LBS Working Pressure				
CR43825	3/8" I.D. X 23/32" O.D.	1/4" NPT	25'	10
CR43850	3/8" I.D. X 23/32" O.D.	1/4" NPT	50'	5



DEALER PRODUCTS, INC.



HOSE and TUBING



HEAVY-DUTY TRUCK AND BUS HEATER HOSE

A Heavy-Duty Heater Hose Designed for Truck and Heavy Equipment Service. High Quality EPDM Tube and Cover that Resists High Temperature, Weathering, Corrosive Solutions, and Additives. Extra-Strength Polyester Reinforcement to Provide Longer Service Life and Minimize Frequency of Replacement. Similar to SAE 20R3, Class R, Grade 1A

DPI Number	Hose Desc.	Hose Length
CR31120	5/8" X 2 Spiral	50'
CR30718	3/4" X 2 Spiral	50'
CR30722	1" X 2 Spiral	50'

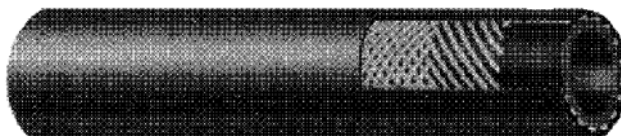

STANDARD BLACK HEATER HOSE

Constructed for General Service on Most Cars and Light Truck Applications. Black EPDM Tube and Cover Designed to Resist Ozone and Engine Heat. High Quality EPDM Inner Tube Handles Coolant Solutions and Additives. Reinforced for High Strength and Resistance to Kinking and Swelling. Manufactured to Meet SAE 20R Class D2

DPI Number	Hose Desc.	Hose Length
CR1825	1/2" X 1" Knit	50'
CR1826	5/8" X 1" Knit	50'
CR1827	3/4" X 1" Knit	50'



DEALER PRODUCTS, INC.



HOSE and TUBING

FUEL LINE AND VACUUM TUBINGS



FUEL LINE AND VAPOR EMISSION HOSE

Meets SAE J-30 Specifications. Nitrile Tube is Reinforced with High Strength Rayon. Neoprene Cover Resists Oil, Grease, and Ozone. Extremely Durable to give Years of Trouble-Free Service for Power Mowers, Automobiles, Snow Throwers, Marine Equipment and Scooters. Flexible and Light-Weight for Fast Easy Installation.

DPI Number	Hose Description	Hose Length	Case
CR25048	3/16"-2 Spiral	25'	6
CR25060	1/4"-2 Spiral	25'	6
CR25078	5/16"-2 Spiral	25'	6
CR25088	3/8"-2 Spiral	25'	6
CR25100	3/8"-2 Spiral	250'	-
CR25106	7/16"-2 Spiral	25'	6



WINDSHIELD WIPER/WASHER AND VACUUM TUBING

Windshield Washer Tubing is Specially Compounded not to Deteriorate or Split from Heat and Ozone Under the Hood. Excellent Oil and Grease Resistance. Applications Include Windshield Washers, Power Antennas, Defrosters, Headlight Vacuum Systems, Power Seats, Power Windows, Etc. Manufactured to Meet SAE J200 BA710.

DPI Number	Hose I.D.	Hose Size	Hose Length	Case Qty.
CR3338	3/32"	Fits 5/16" Nipple	50'	6
CR3339	7/64"	Fits 1/8" Nipple	50'	6
CR3340	5/32"	Fits 3/16" Nipple	50'	6
AWP101021	3/16"		50'	6
CR3341	7/32"	Fits 1/4" Nipple	50'	6
CR3342	9/32"	Fits 5/16" Nipple	50'	6



DEALER PRODUCTS, INC.



DEALER PRODUCTS SHOP AIR HOSE

The Best Air Hose Money can Buy. Made to Length in our Arlington, Texas Warehouse. For Hose Specifications, See SF203 Series Hose on J-027 of the Dealer Products Catalog.

DPI Number	Hose Description	Fitting Size	Hose Length
SF203625	3/8" I.D. X .61 O.D.	1/4" NPT	25'
SF203630	3/8" I.D. X .61 O.D.	1/4" NPT	30'
SF203650	3/8" I.D. X .61 O.D.	1/4" NPT	50'

MADE TO ORDER LENGTHS

We Will Custom Build these Hoses to Any Length you Specify. These Must be Ordered as a Special Item. Please Order as (S) SF2036_ _ . (Insert the Length of Hose in Feet in the Blanks.)



MO72157

7 ft. Fuel Injection Hose;
Fits M71124, M74000, and
M75000 (Fuel Inj. Tools);





DEALER PRODUCTS, INC.

MULTI-CUTTER

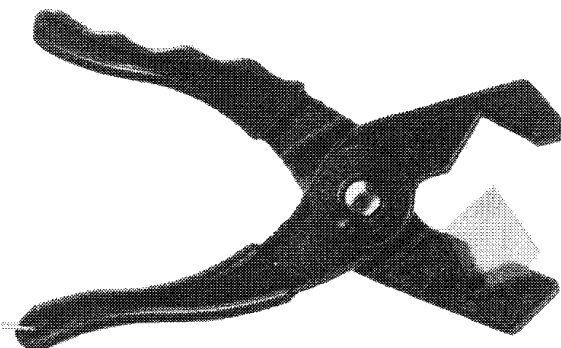
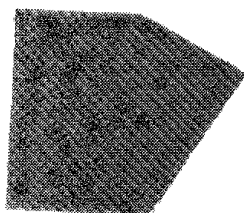

Tempered Swedish Steel Blade Housed Within a Metal Body. Finished with Powder Coating for Protection and Durability. Features: PVC Coated Handles, Cutting Tension Controlled by Spring Steel A.D. Handle Lock. The Multi-Cutter has Been Designed to Provide a Clean, Accurate Cut to Such Materials as:

- > Heater Hose
- > Fuel Line Hose
- > Starter Cable Hose
- > PVC Pipe
- > Nylon Tubing
- > Copper Tractor Trailer Cable
- > Body Side Moulding
- > 12 Volt Battery Cable
- > Windshield Channeling
- > Non-Metal Air Brake Hose

ADDG1000A

Multi-Cutter

ADDG100A

Replacement Blades

**NOTE: BLADES ARE SOLD AND
PRICED BY THE PAIR**



DEALER PRODUCTS, INC.

BRASS FITTINGS INVERTED FLARE



STANDARD NUT (STEEL)

DPI Number	Tube Size
WH105X3	3/16"
WH105X4	1/4"
WH105X5	5/16"
WH105X6	3/8"



UNION

DPI Number	Tube Size
WH302X3	3/16"
WH302X4	1/4"
WH302X5	5/16"
WH302X6	3/8"

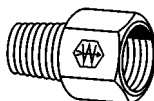

MALE CONNECTOR

DPI Number	Tube Size	Pipe Thread
WH202X3	3/16"	1/8
WH202X4	1/4"	1/4
WH202X5	5/16"	1/8
WH202X5X4	5/16"	1/4
WH202X6	3/8"	1/8
WH202X6X2	3/8"	1/8



DEALER PRODUCTS, INC.

BRASS FITTINGS INVERTED FLARE

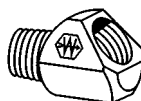

45° MALE ELBOW

DPI Number	Tube Size	Pipe Thread
WH352X4	1/4"	1/8"
WH352X6	3/8"	1/4"

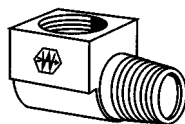

MALE ELBOW

DPI Number	Tube Size	Pipe Thread
WH402X4	1/4"	1/8"
WH402X4X4	1/4"	1/4"
WH402X5	5/16"	1/8"
WH402X5X4	5/16"	1/4"
WH402X6	3/8"	1/4"
WH402X6X2	3/8"	1/8"
WH402X8	1/2"	3/8"



DEALER PRODUCTS, INC.

BRASS FITTINGS SAE 45° FLARE

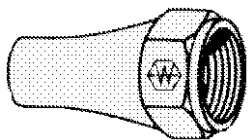

LONG NUT

DPI Number	Tube Size
WH41X10	5/8"

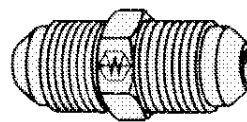

UNION

DPI Number	Tube Size
WH42X4	1/4"
WH42X6	3/8"
WH42X8	1/2"
WH42X10	5/8"

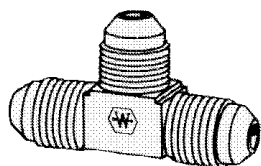

UNION TEE

DPI Number	Tube Size
WH44X5	5/16"

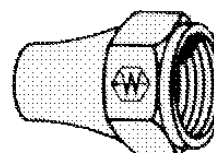

SHORT NUT

DPI Number	Tube Size
WH1110X4	1/4"
WH1110X6	3/8"
WH1110X8	1/2"

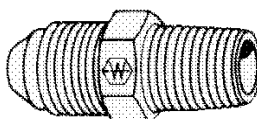

MALE CONNECTOR

DPI Number	Tube Size	Pipe Thread
WH48X4	1/4"	1/8
WH48X4X4	1/4"	1/4
WH48X5	5/16"	1/8
WH48X5X4	5/16"	1/4
WH48X6	3/8"	1/4
WH48X6X2	3/8"	1/8
WH48X6X6	3/8"	3/8
WH48X6X8	3/8"	1/2
WH48X8	1/2"	3/8
WH48X8X8	1/2"	1/2
WH48X10	5/8"	1/2
WH48X10X6	5/8"	3/8



DEALER PRODUCTS, INC.

BRASS FITTINGS SAE 45° FLARE

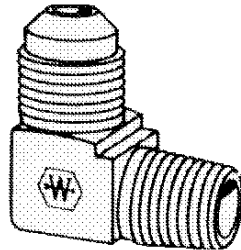

MALE ELBOW

DPI Number	Tube Size	Pipe Thread
WH49X4	1/4"	1/8
WH49X4X4	1/4"	1/4
WH49X4X6	1/4"	3/8
WH49X5	5/16"	1/8
WH49X6	3/8"	1/4
WH49X6X2	3/8"	1/8
WH49X6X6	3/8"	3/8
WH49X6X8	3/8"	1/2
WH49X8	1/2"	3/8
WH49X8X8	1/2"	1/2
WH49X10	5/8"	1/2
WH49X10X6	5/8"	3/8

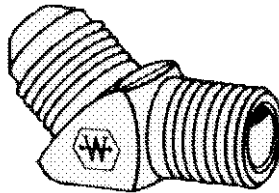

MALE ELBOW

DPI Number	Tube Size	Pipe Thread
WH54X4	1/4"	1/8
WH54X10	5/8"	1/2



DEALER PRODUCTS, INC.

BRASS FITTINGS COMPRESSION

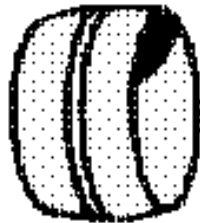

SLEEVE

DPI Number	Tube Size
WH60X2	1/8"
WH60X3	3/16"
WH60X4	1/4"
WH60X5	5/16"
WH60X6	3/8"
WH60X8	1/2"

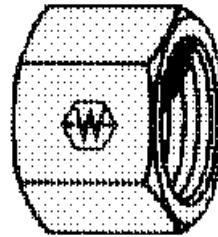

NUT

DPI Number	Tube Size
WH61X3	3/16"
WH61X4	1/4"
WH61X5	5/16"
WH61X6	3/8"

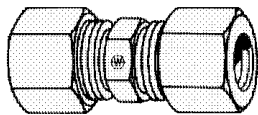

UNION

DPI Number	Tube Size
WH62X2	1/8"
WH62X3	3/16"
WH62X4	1/4"
WH62X5	5/16"
WH62X6	3/8"
WH62X8	1/2"
WH62X10	5/8"

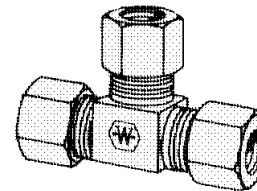

UNION TEE

DPI Number	Tube Size
WH64X4	1/4"
WH64X5	5/16"
WH64X6	3/8"
WH64X8	1/2"

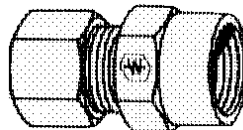

FEMALE CONNECTOR

DPI Number	Tube Size	Pipe Thread
WH66X2	1/8"	1/8



DEALER PRODUCTS, INC.

BRASS FITTINGS COMPRESSION

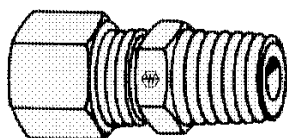

MALE CONNECTOR

DPI Number	Tube Size	Pipe Thread
WH68X2	1/8"	1/8
WH68X3	3/16"	1/8
WH68X4	1/4"	1/8
WH68X4X4	1/4"	1/4
WH68X5	5/16"	1/8
WH68X6	3/8"	1/4
WH68X6X2	3/8"	1/8
WH68X6X6	3/8"	3/8
WH68X8	1/2"	3/8

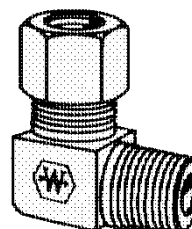

MALE ELBOW

DPI Number	Tube Size	Pipe Thread
WH69X2	1/8"	1/8
WH69X4	1/4"	1/8
WH69X4X4	1/4"	1/4
WH69X5	5/16"	1/8
WH69X6	3/8"	1/4
WH69X8	1/2"	3/8

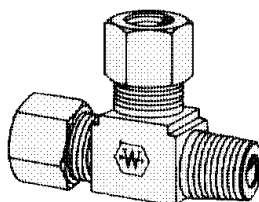

MALE RUN TEE

DPI Number	Tube Size	Pipe Thread
WH71X4	1/4"	1/8



DEALER PRODUCTS, INC.

BRASS FITTINGS SELF-ALIGN

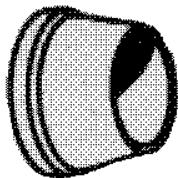

SLEEVE

DPI Number	Tube Size
WH601X2	1/8"

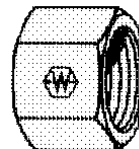

NUT

DPI Number	Tube Size
WH611X2	1/8"

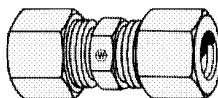

UNION

DPI Number	Tube Size
WH621X2	1/8"

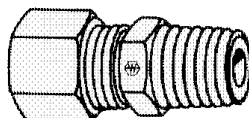

MALE CONNECTOR

DPI Number	Tube Size	Pipe Thread
WH681X2	1/8"	1/8
WH681X2X1	1/8"	1/16

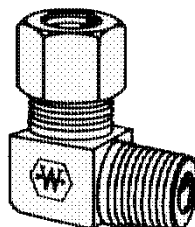

MALE ELBOW

DPI Number	Tube Size	Pipe Thread
WH691X2	1/8"	1/8



DEALER PRODUCTS, INC.

BRASS FITTINGS THREADED SLEEVE

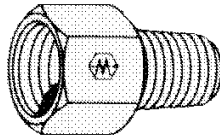

MALE CONNECTOR

DPI Number	Tube Size	Pipe Thread
WH6200X2	1/8"	1/8"

COMPRESSION FITTINGS FOR FULLER TRANSMISSIONS

- > Designed for Use with Polyethylene Nylon and Plastic Tubing
- > All Brass Construction



NUT

DPI Number	Tube Size	Qty Pkg
VL011012	1/8"	5



FULL UNION

DPI Number	Tube Size	Qty Pkg
VL011032	1/8"	5



MALE CONNECTOR

DPI Number	Tube Size	Pipe Thread	Qty Pkg
VLO12016	1/8"	1/16"	5



MALE ELBOW

DPI Number	Tube Size	Pipe Thread	Qty Pkg
VLO12066	1/8"	1/8"	5



DEALER PRODUCTS, INC.

BRASS FITTINGS PIPE

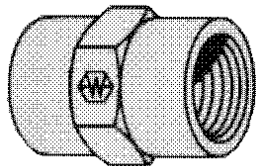

COUPLING

DPI Number	Pipe Thread
WH3300X2	1/8
WH3300X4	1/4
WH3300X6	3/8
WH3300X8	1/2
WH3300X12	3/4

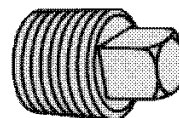

SQUARE HEAD PLUG

DPI Number	Pipe Thread
WH3151X2	1/8
WH3151X4	1/4
WH3151X6	3/8
WH3151X8	1/2
WH3151X12	3/4

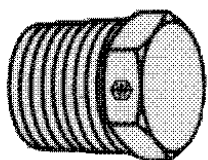

HEX HEAD PLUG

DPI Number	Pipe Thread
WH3152X2	1/8
WH3152X4	1/4
WH3152X6	3/8
WH3152X8	1/2
WH3152X12	3/4

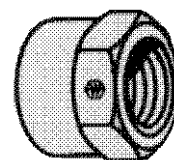

CAP

DPI Number	Pipe Thread
WH3129X2	1/8
WH3129X4	1/4
WH3129X6	3/8

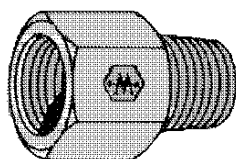

ADAPTER

DPI Number	Female Thread	Male Thread
WH3200X2	1/8	1/8
WH3200X4	1/4	1/4
WH3200X4X2	1/4	3/8
WH3200X6	3/8	1/8
WH3200X6X4	3/8	1/4
WH3200X8X6	1/2	3/8

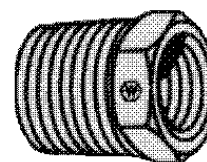

BUSHING

DPI Number	Female Thread	Male Thread
WH3220X4X2	1/8	1/4
WH3220X6X2	1/8	3/8
WH3220X6X4	1/4	3/8
WH3220X8X2	1/8	1/2
WH3220X8X4	1/4	1/2
WH3220X8X6	3/8	1/2
WH3220X12X6	3/8	3/4
WH3220X12X8	1/2	3/4



DEALER PRODUCTS, INC.

BRASS FITTINGS PIPE

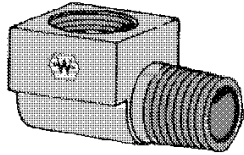

STREET ELBOW

DPI Number	Pipe Thread
WH3400X2	1/8
WH3400X4	1/4
WH3400X6	3/8
WH3400X8	1/2

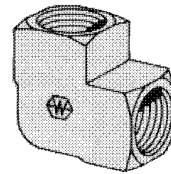

ELBOW

DPI Number	Pipe Thread
WH3500X2	1/8
WH3500X4	1/4
WH3500X6	3/8
WH3500X8	1/2
WH3500X12	3/4

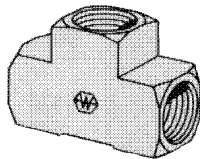

TEE

DPI Number	Pipe Thread
WH3700X2	1/8
WH3700X4	1/4
WH3700X6	3/8
WH3700X8	1/2

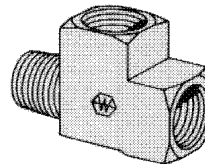

STREET TEE

DPI Number	Pipe Thread
WH3750X4	1/4
WH3750X6	3/8
WH3750X8	1/2



DEALER PRODUCTS, INC.

BRASS FITTINGS PIPE

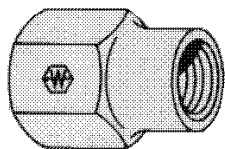

REDUCE COUPLING

DPI Number	Pipe Thread
WH3300X4X2	1/4 X 1/8
WH3300X6X2	3/8 X 1/8
WH3300X6X4	3/8 X 1/4
WH3300X8X6	1/2 X 3/8

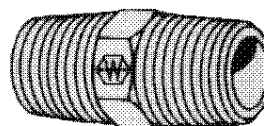

HEX NIPPLE

DPI Number	Pipe Thread
WH3325X2	1/8
WH3325X4	1/4
WH3325X4X2	1/4 X 1/8
WH3325X6	3/8
WH3325X6X4	3/8 X 1/4
WH3325X8	1/2

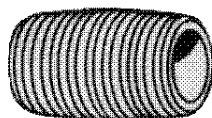

CLOSE NIPPLE

DPI Number	Pipe Thread
WH3326X2	1/5
WH3326X4	1/4
WH3326X6	3/8
WH3326X8	1/2
WH3326X12	3/4

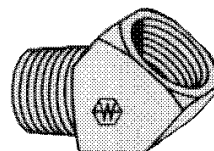

45° STREET ELBOW

DPI Number	Pipe Thread
WH3350X2	1/8
WH3350X4	1/4
WH3350X6	3/8
WH3350X8	1/2



LONG NIPPLE

DPI Number	Pipe Thread	Nipple Length
WH3327X2	1/8	1-1/2"
WH3327X4	1/4	1-1/2"
WH3327X6	3/8	1-1/2"
WH3327X8	1/2	1-1/2"
WH3328X2	1/8	2"
WH3328X4	1/4	2"
WH3328X6	3/8	2"
WH3328X8	1/2	2"
WH3329X8	1/2	2-1/2"



DEALER PRODUCTS, INC.

BRASS FITTINGS DRAIN & SHUT-OFF COCKS

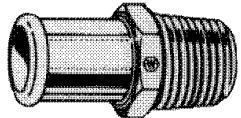

DPI Number	Tube Size	Pipe Thread
WH1411	5/8"	3/8
WH1431	5/8"	1/2

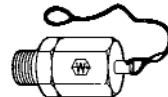

AIR TANK DRAIN VALVE 5 Ft. Remote Cable; 150 PSI Max

DPI Number	Pipe Thread
WH142160	1/4"

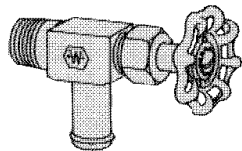

DPI Number	Hose Size	Pipe Thread
WH1422	3/8"	3/8
WH1423	5/8"	3/8
WH1433	3/4"	3/8

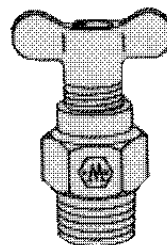

INTERNAL SEAT

DPI Number	Pipe Thread
WH1425	1/4"

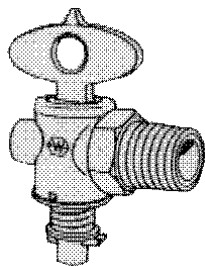

DRAINCOCK

DPI Number	Pipe Thread
WHW15310	1/4"

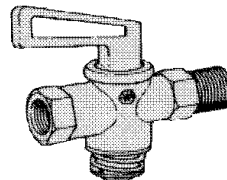

MALE & FEMALE PIPE SHUT-OFF

DPI Number	Pipe Thread
WH6829	1/4"



WH1451

Drain Cock - Pipe to Hose Shut-Off (Brass Body);

Hose Size: 3/4"; Male Pipe Thread: 1/2"

1 per package

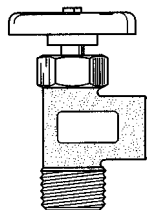

PHV405P88

1/2" X 1/2" Ball Valve;
Female Pipe to Male Pipe;

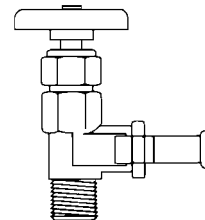

VL023108

Truck Valve (Hose to Female Pipe)

Hose I.D.: 3/4";
Pipe Thread: 1/2"

1 per package



DEALER PRODUCTS, INC.

BRASS FITTINGS DRAIN & SHUT-OFF COCKS

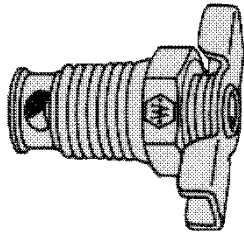

EXTERNAL SEAT

DPI Number	Pipe Thread
WH135	1/8"
WH145	1/4"
WH270	3/8"

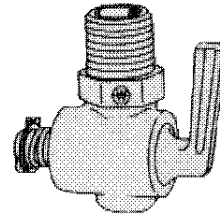

GROUND PLUG DRAIN

DPI Number	Pipe Thread
WH6892	1/4"

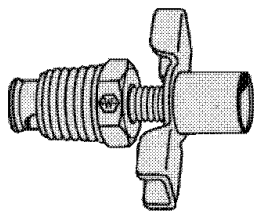

EXTERNAL SEAT

DPI Number	Pipe Thread
WH6788	1/4"

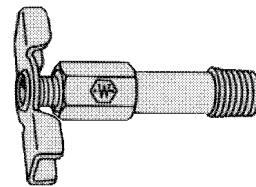

INTERNAL SEAT - Long

DPI Number	Pipe Thread
WH185	1/8"

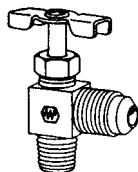

WH330

Needle Valve, SAE 45 Deg.
Flare Angle, Brass;
Tube O.D.: 3/8";
Male Pipe Thread: 1/4";
1 per package

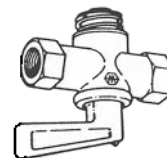

GROUND PLUG DRAIN - Female Pipe

DPI Number	Fem Pipe Thread
WH6809	1/4"



DEALER PRODUCTS, INC.

HOSE END FITTINGS FUEL & OIL LOW PRESSURE

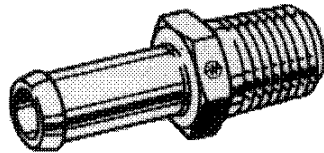

MALE PIPE

<u>DPI Number</u>	<u>Hose I.D.</u>	<u>Pipe Thread</u>
WH1581	1/4"	1/4-18
WH1551	5/16"	1/8-27
WH1555	5/16"	1/4-18
WH1564	3/8"	1/4-18

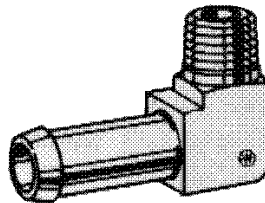

MALE PIPE 90° Elbow

<u>DPI Number</u>	<u>Hose I.D.</u>	<u>Pipe Thread</u>
WH1556	5/16"	1/8-27
WH1557	5/16"	1/4-18
WH1571	3/8"	1/4-18
WH1582	1/4"	1/8-27



DEALER PRODUCTS, INC.

HOSE END FITTINGS PUSH-ON LOW PRESSURE

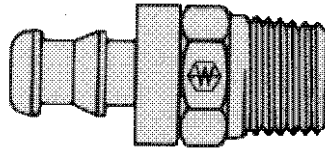

MALE PIPE - RIGID

DPI Number	Hose I.D.	Pipe Size	Thread Size	Hex Size	Hole Diameter
WH10004B102	1/4"	1/8"	1/8-27	7/16	11/64
WH10004B104	1/4"	1/4"	1/4-18	9/16	11/64
WH10006B104	3/8"	1/4"	1/4-18	9/16	19/64
WH10006B106	3/8"	3/8"	3/8-18	11/16	19/64

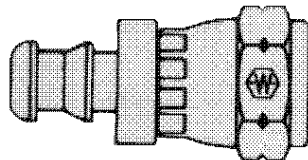

FEMALE SWIVEL SAE 45° FLARE

DPI Number	Hose Size	Tube Size	Thread Size	Hex Size	Hole Diameter
WH10004B404	1/4"	1/4"	7/16-20	9/16	11/64
WH10006B406	3/8"	3/8"	5/8-18	3/4	19/64
WH10008B408	1/2"	1/2"	3/4-16	7/8	25/64

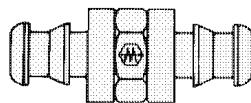

HOSE MENDER

DPI Number	Hose I.D.	Hex Size	Hole Diameter
WH10006BY06	3/8"	5/8	19/64
WH10008BY08	1/2"	3/4	25/64

 **DEALER PRODUCTS, INC.** 
NOTES



DEALER PRODUCTS, INC.

BRASS FITTINGS INSERTS

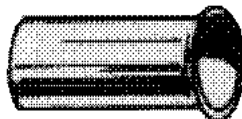

DPI Number	Tube O.D.	Tube Size
WH2030X4*	#4	1/4" (.250)
WH2030X44**	#4	1/4" (.250)
WH2030X5	#5	5/16" (.312)
WH2030X6	#6	3/8" (.375)
WH2030X8	#8	1/2" (.500)
WH2030X10	#10	5/8" (.625)

* For Tubing with .126 I.D./0.062 Wall Thickness

** For Tubing with .170 I.D./0.040 Wall Thickness

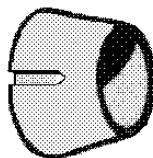

EG1209910
Split Type Ferrel



DEALER PRODUCTS, INC.

AIR BRAKE FITTINGS FOR COPPER TUBING

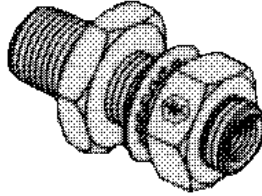

BULKHEAD COUPLINGS

<u>DPI Number</u>	<u>Tube Size</u>	<u>Pipe Thread</u>	<u>Coupling Length</u>
WHW05498	1/2"	1/4"	2-5/32"



DEALER PRODUCTS, INC.



PRESTOMATIC Push-In Air Brake Fittings

Fittings Meet D.O.T. FMVSS 571.106 Air Brake Performance Specifications. Working Pressure for 27" Hg Vacuum to 250 psi. Working Temperature from -40° F to +200° F. Buna N (Nitrile) O-Rings.

DPI Number	Tube Size	Fitting Length	Fitting O.D.	Qty Pkg
PH62PMT4	1/4"	1.34"	.50"	1
PH62PMT6	3/8"	1.84"	.75"	1

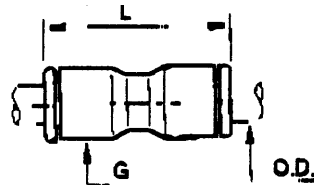

SH31065400

Splicer
5/32" Tubing

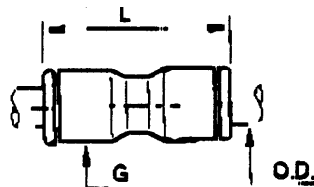

SH31065300

Splicer
1/8" Tubing



DEALER PRODUCTS, INC.

BRASS FITTINGS SPECIAL PURPOSE

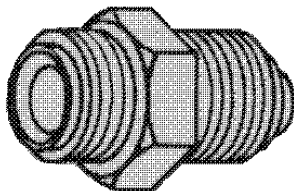

INV. FLARE TO SAE 45° FLARE ADAPTER

DPI Number	Inv. Flare	SAE Thread
WH1553	5/16"	3/8"

HYDRAULIC BRAKE FITTINGS

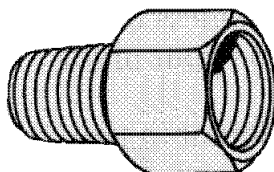

DUAL MASTER CYLINDER ADAPTER

DPI Number	Inv. Male Thread	Inv. Female Thread
WH7917	1/4"	5/16"

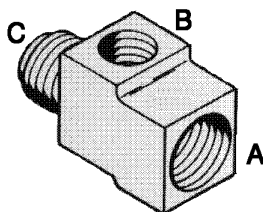

TOWED TRAILER BRAKE TEE

DPI Number	Tube Size A	B	Male Thread C
WH7905	3/16(9/16-20)	3/16(3/8-24)	3/16 inv.(9/16-20)



DEALER PRODUCTS, INC.

AIR BRAKE FITTINGS FOR NYLON TUBING

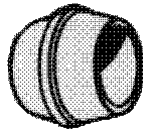

SLEEVE

DPI Number	Tube O.D.
WH1460X4	1/4"
WH1460X6	3/8"
WH1460X8	1/2"
WH1460X10	5/8"
WH1460X12	3/4"

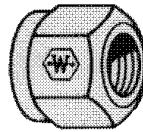

NUT

DPI Number	Tube O.D.
WH1461X4	1/4"
WH1461X6	3/8"
WH1461X8	1/2"
WH1461X10	5/8"

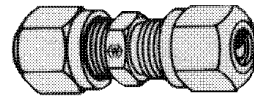

UNION

DPI Number	Tube O.D.
WH1462X4	1/4"
WH1462X6	3/8"
WH1462X8	1/2"
WH1462X10	5/8"
WH1462X12	3/4"

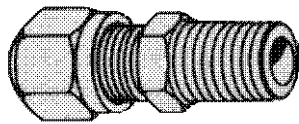

MALE CONNECTOR

DPI Number	Tube O.D.	Pipe Thread
WH1468X4	1/4"	1/8"
WH1468X4X4	1/4"	1/4"
WH1468X4X6	1/4"	3/8"
WH1468X6	3/8"	1/4"
WH1468X6X2	3/8"	1/8"
WH1468X6X6	3/8"	3/8"
WH1468X6X8	3/8"	1/2"
WH1468X8	1/2"	3/8"
WH1468X8X4	1/2"	1/4"
WH1468X8X8	1/2"	1/2"
WH1468X10	5/8"	3/8"
WH1468X10X6	5/8"	1/2"

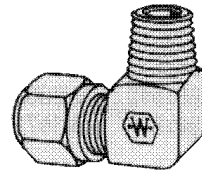

90° MALE ELBOW

DPI Number	Tube O.D.	Pipe Thread
WH1469X4	1/4"	1/8"
WH1469X4X4	1/4"	1/4"
WH1469X6	3/8"	1/4"
WH1469X6X2	3/8"	1/8"
WH1469X6X6	3/8"	3/8"
WH1469X6X8	3/8"	1/2"
WH1469X8	1/2"	3/8"
WH1469X8X4	1/2"	1/4"
WH1469X8X8	1/2"	1/2"
WH1469X10	5/8"	1/2"
WH1469X10X6	5/8"	3/8"



DEALER PRODUCTS, INC.

AIR BRAKE FITTINGS FOR NYLON TUBING

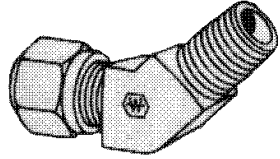

45° MALE ELBOW

DPI Number	Tube O.D.	Pipe Thread
WH1480X4	1/4"	1/8
WH1480X6	3/8"	1/4
WH1480X6X6	3/8"	3/8
WH1480X8	1/2"	3/8
WH1480X8X8	1/2"	1/2

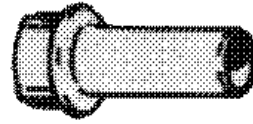

INSERTS

DPI Number	Tube O.D.
WH1484X4	1/4"
WH1484X6	3/8"
WH1484X8	1/2"
WH1484X10	5/8"
WH1484X12	3/4"

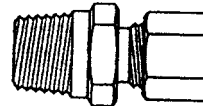
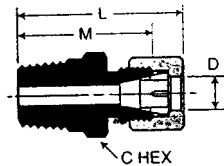

DPI Number	Tube Size	D	L	Strt Thread	M	C Hex
PH68TF5322	5/32	.068	.96	5/16-24	.78	7/16

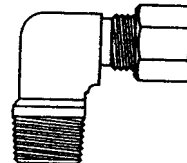
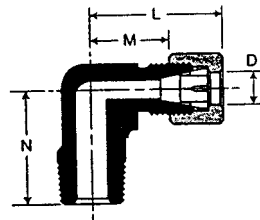

DPI Number	Tube Size	D	L	Strt Thread	M	N
PH269TF5322	5/32	.068	.79	5/16-24	.61	.66



DEALER PRODUCTS, INC.

AIR BRAKE FITTINGS FOR NYLON TUBING



UNIONS
Joins Tubing

Part Number	Tube O.D.
WH1862X2.5	5/32"
WH1862X4	1/4"
WH1862X6	3/8"
WH1862X8	1/2"
WH1862X10	5/8"

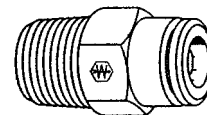

MALE CONNECTOR

Part Number	Tube O.D.	Male Pipe Thread
WH1868X2.5	5/32"	1/8"
WH1868X2.5X1	5/32"	1/16"
WH1868X3	3/16"	1/8"
WH1868X4	1/4"	1/8"
WH1868X4X4	1/4"	1/4"
WH1868X6	3/8"	1/4"
WH1868X6X6	3/8"	3/8"
WH1868X8	1/2"	3/8"
WH1868X10	5/8"	1/2"

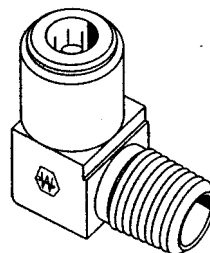

MALE ELBOW 90°

Part Number	Tube O.D.	Male Pipe Thread
WH1869X2.5	5/32"	1/8"
WH1869X2.5X1	5/32"	1/16"
WH1869X3	3/16"	1/8"
WH1869X4	1/4"	1/8"
WH1869X4X4	1/4"	1/4"
WH1869X6	3/8"	1/4"
WH1869X6X6	3/8"	3/8"
WH1869X8	1/2"	3/8"
WH1869X10	5/8"	1/2"



DEALER PRODUCTS, INC.

AIR BRAKE FITTINGS

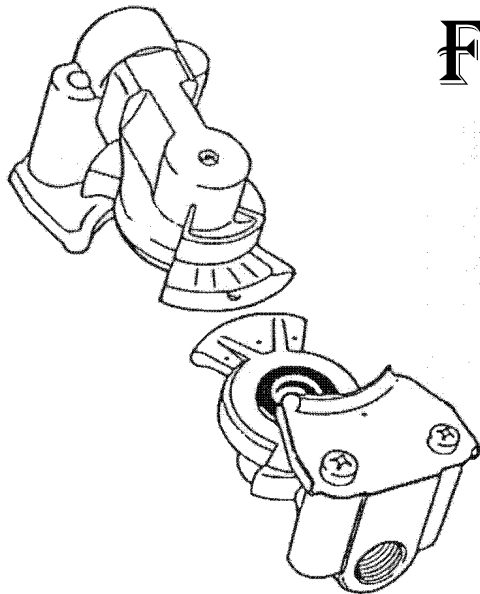

WHW75150 UNIVERSAL GLADHAND COUPLING

- > Die Cast Aluminum Body
- > Conforms to SAE J318
- > Connects to 1/2" Pipe
- > Connects to All Styles

STEEL FITTINGS PIPE

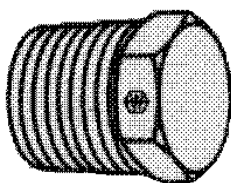

HEX HEAD

DPI Number	Pipe Thread
WHC3159X2	1/8
WHC3159X4	1/4
WHC3159X6	3/8
WHC3159X8	1/2

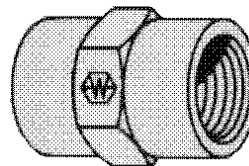

COUPLING

DPI Number	Pipe Thread
WHC3309X6	3/8



DEALER PRODUCTS, INC.

STEEL FITTINGS SAE 37° (JIC) FLARE-TWIN

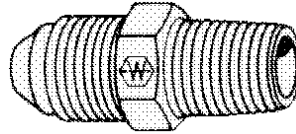

MALE CONNECTOR

DPI Number	Tube Size	Pipe Thread
WHC5205X4X4	1/4"	1/4

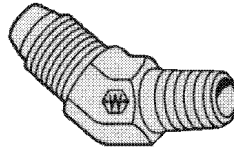

45° MALE ELBOW

DPI Number	Tube Size	Pipe Thread
WHC5355X12	3/4"	3/4



DEALER PRODUCTS, INC.

STRATOFLEX LOW PRESSURE - STRATOGRIP HOSE FITTINGS *GROUP XI*

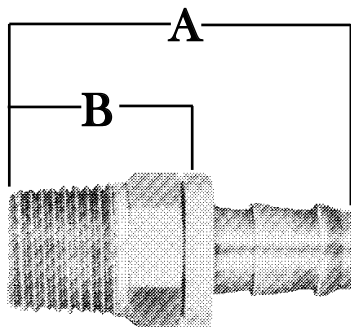

82 SERIES

MALE PIPE - BRASS

DPI Number	Hose Size	Pipe Thread	A	B	Hex
SF44146B	6	1/4-18	1.78"	.88"	9/16"



DEALER PRODUCTS, INC.

STRATOFLEX DIESEL HOSE FITTINGS

GROUP XIII

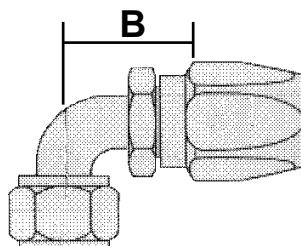

**90° ELBOW SWIVEL
SAE 37°/45° PTT 30° FLARE**

DPI Number	Hose Size	Pipe Thread	B Cut-Off Allowance
SF2723166S	6	9/16-18	1.06

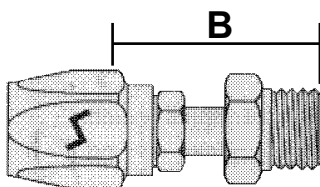

INVERTED FLARE SWIVEL

DPI Number	Hose Size	Pipe Thread	B Cut-Off Allowance
SF2758755S	5	1/2-20	1.58
SF2758766S	6	5/8-18	1.66



DEALER PRODUCTS, INC.

STRATOFLEX DIESEL HOSE FITTINGS

GROUP XIII

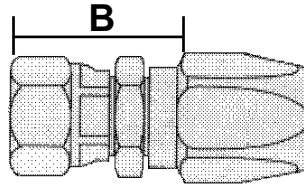

**PTT 30° FLARE SWIVEL
NON-MANDREL**

DPI Number	Hose Size	Pipe Thread	B Cut-Off Allowance
SF7241616S	16	1-5/16-14	1.66

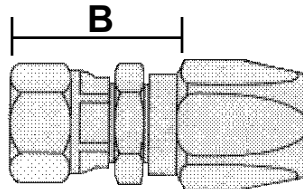

**SAE 45° FLARE SWIVEL
NON-MANDREL**

DPI Number	Hose Size	Pipe Thread	B Cut-Off Allowance
SF72544S	4	7/16-20	1.14
SF72555S	5	1/2-12	1.15
SF72566S	6	5/8-18	1.30
SF72588S	8	3/4-16	1.50
SF7251010S	10	7/8-14	1.80
SF7251212S	12	1-1/16-14	1.72

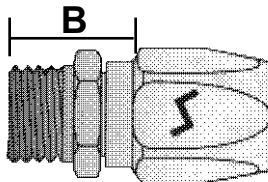

MALE PIPE NON-MANDREL

DPI Number	Hose Size	Pipe Thread	B Cut-Off Allowance
SF72624S	4	1/8-27	.84
SF72644S	4	1/4-18	1.06

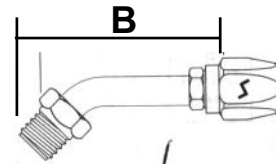

**45° INVERTED FLARE SWIVEL -
REUSABLE**

DPI Number	Hose Size	Pipe Thread	B Cut-Off Allowance
SF2765955S	5	1/2-20	1.83



DEALER PRODUCTS, INC.

MISCELLANEOUS HOSE FITTINGS

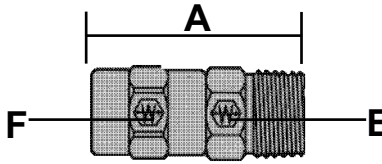

HOSE ENDS

Reusable 009 "B" Series

MALE PIPE - RIGID

DPI Number	Hose I.D.	Pipe Size	Thread Size	A	Cut-Off Factor	Hole Diameter	Hex E	Hex F
WH00906B104	3/8	1/4	1/4-18	1.48	15/16	.281	9/16	13/16

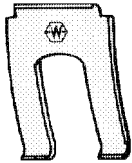

WH5188
Clip or Spring Lock for Brake Hose

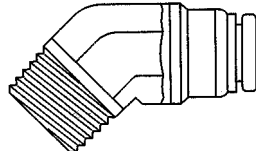

PH279PMTNS42
Air Brake Push-In Fittings;
Male Elbow: Non-Swivel 45°;
Tube Size: 1/4"; Pipe Thread: 1/8";

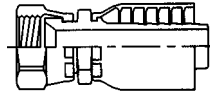

PH1064386
1/2" Female Fitting;
JIC 37° - Swivel Straight;

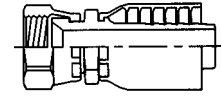

PH1064388
1/2" Female Hydraulic Fitting;
JIC 37° - Swivel Straight;

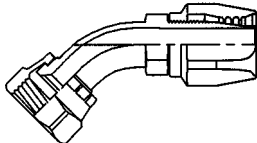

PH2372188
Female JIC 37° - Swivel;
45° Elbow - Short Drop;
1/2" Thread;

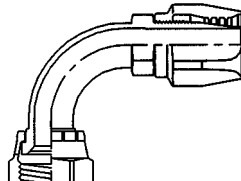

PH2392188
Female JIC 37° - Swivel;
90° Elbow - Short Drop;
1/2" Thread;

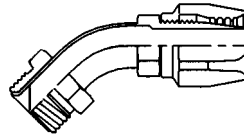

PH2672155
Male Inverted SAE 45° - Swivel;
45° Elbow;
1/2" Thread;

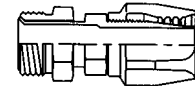

PH2282155
Male Inverted SAE 45° - Swivel;
Straight;
Thread: 5/16";

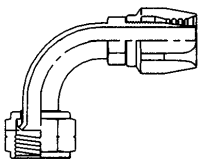

PH2792166
Female SAE 45° - Swivel;
90° Elbow;
3/8" Thread;

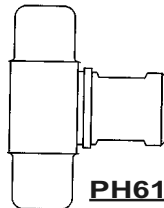

PH6125X16
Wing Nut Coupler - Brass;
Body Size: 1"; Thread Size NPTF: 1-11 1/2;
For Use with PH6105X16;

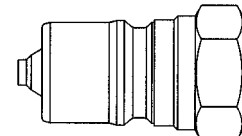

PHH863
Female Thread Nipple - Steel
Body Size: 1";
Thread Size NPTF: 1-1-1/2;
For Use with PHH862;

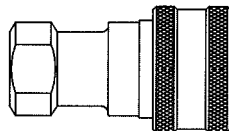

PHH862
Female Thread Coupler - Steel
Body Size: 1";
Thread Size NPTF: 1-11-1/2;
For Use with PHH863;
1 per package

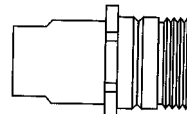

PH6105X16
6100 Series Nipple - Brass without Flange;
Body Size: 1"; Thread Size NPTF: 1-11 1/2;
For Use with PH6125X16;
1 per package



DEALER PRODUCTS, INC.

AIR BRAKE FITTINGS FOR COPPER TUBING

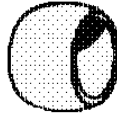

SLEEVE

<u>DPI Number</u>	<u>Tube O.D.</u>
WH1360X6	3/8"
WH1360X8	1/2"
WH1360X12	3/4"

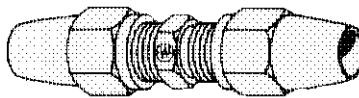

UNION

<u>DPI Number</u>	<u>Tube O.D.</u>
WH1362X4	1/4"
WH1362X6	3/8"
WH1362X8	1/2"

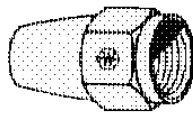

NUT

<u>DPI Number</u>	<u>Tube O.D.</u>
WH1361X8	1/2"



DEALER PRODUCTS, INC.

AIR BRAKE FITTINGS FOR COPPER TUBING

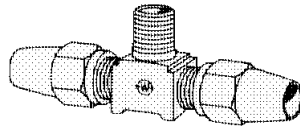

MALE BRANCH TEE

DPI Number	Tube O.D.	Male Pipe Thread
WH1372X8	1/2	3/8

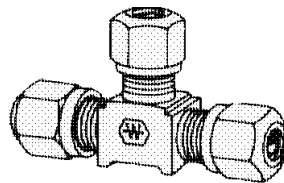

UNION TEE

DPI Number	Tube O.D.
WH1464X4	1/4
WH1464X6	3/8

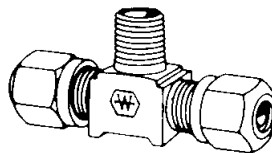

MALE BRANCH TEE

DPI Number	Tube O.D.	Male Pipe Thread
WH1472X6	3/8	1/4



DEALER PRODUCTS, INC.

AIR BRAKE FITTINGS FOR COPPER TUBING



SLEEVE

DPI Number	Hose I.D.
WH33806A	3/8

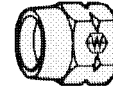

NUT

DPI Number	Hose I.D.
WH33806B	3/8

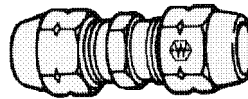

HOSE MENDER

DPI Number	Hose I.D.
WH33806BY06	3/8

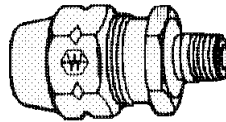

CONNECTOR

DPI Number	Hose I.D.	Male Pipe Thread
WH33806BY24	3/8	1/4
WH33806BY26	3/8	3/8
WH33806BY28	3/8	1/2

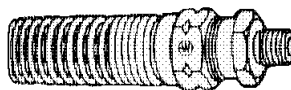

CONNECTOR WITH SPRING GUARD

DPI Number	Hose I.D.	Male Pipe Thread
WH33806BY34	3/8	1/4
WH33806BY36	3/8	3/8
WH33806BY38	3/8	1/2



DEALER PRODUCTS, INC.

BRASS HOSE FERRULES



Brass Hose Ferrules

Economical and dependable brass ferrules enable you to make up custom hose assemblies.

Part Number	I.D.	Fits Hose O.D.
AWM16545	1" X .625"	5/8"
AWM16546	1" X .656"	21/32"
AWM16547	1" X .687"	11/16"
AWM16548	1" X .718"	23/32"
AWM16549	1" X .718"	3/4"